

koty 12 a 17mm su vzdialenosti vonk. hrany zakl. prahov od zakladovej dosky

CL4		
3	1x	623/Semelle d'implantation 4753
8	1x	623/Semelle d'implantation 5318
15	1x	623/Semelle d'implantation 2306
21	1x	623/Semelle d'implantation 4321
25	1x	623/Semelle d'implantation 4863
29	1x	623/Semelle d'implantation 6337
35	1x	623/Semelle d'implantation 5365
39	1x	623/Semelle d'implantation 6238
44	1x	623/Semelle d'implantation 6490
48	2x	623/Semelle d'implantation 7041
50	2x	623/Semelle d'implantation 5102
54	1x	623/Semelle d'implantation 5383
56	1x	623/Semelle d'implantation 6446
60	1x	623/Semelle d'implantation 6384
67	1x	623/Semelle d'implantation 4489
69	1x	623/Semelle d'implantation 3780
76	1x	623/Semelle d'implantation 956
78	1x	623/Semelle d'implantation 1056
80	1x	623/Semelle d'implantation 2077
83	1x	623/Semelle d'implantation 2306
86	2x	623/Semelle d'implantation 2109
89	1x	623/Semelle d'implantation 4731

indice	date	modifications	nom
A	13-10-2017		CM

Projet: RD Zábojníkovci	Carnet: 050 (plancad n° 050)	Echelle: 1/10°
Maitre d'ouvrage:	Chargé d'Affaire:	N° d'affaire:
Nom du plan: zakladacie prahy		
Dessinateur:		

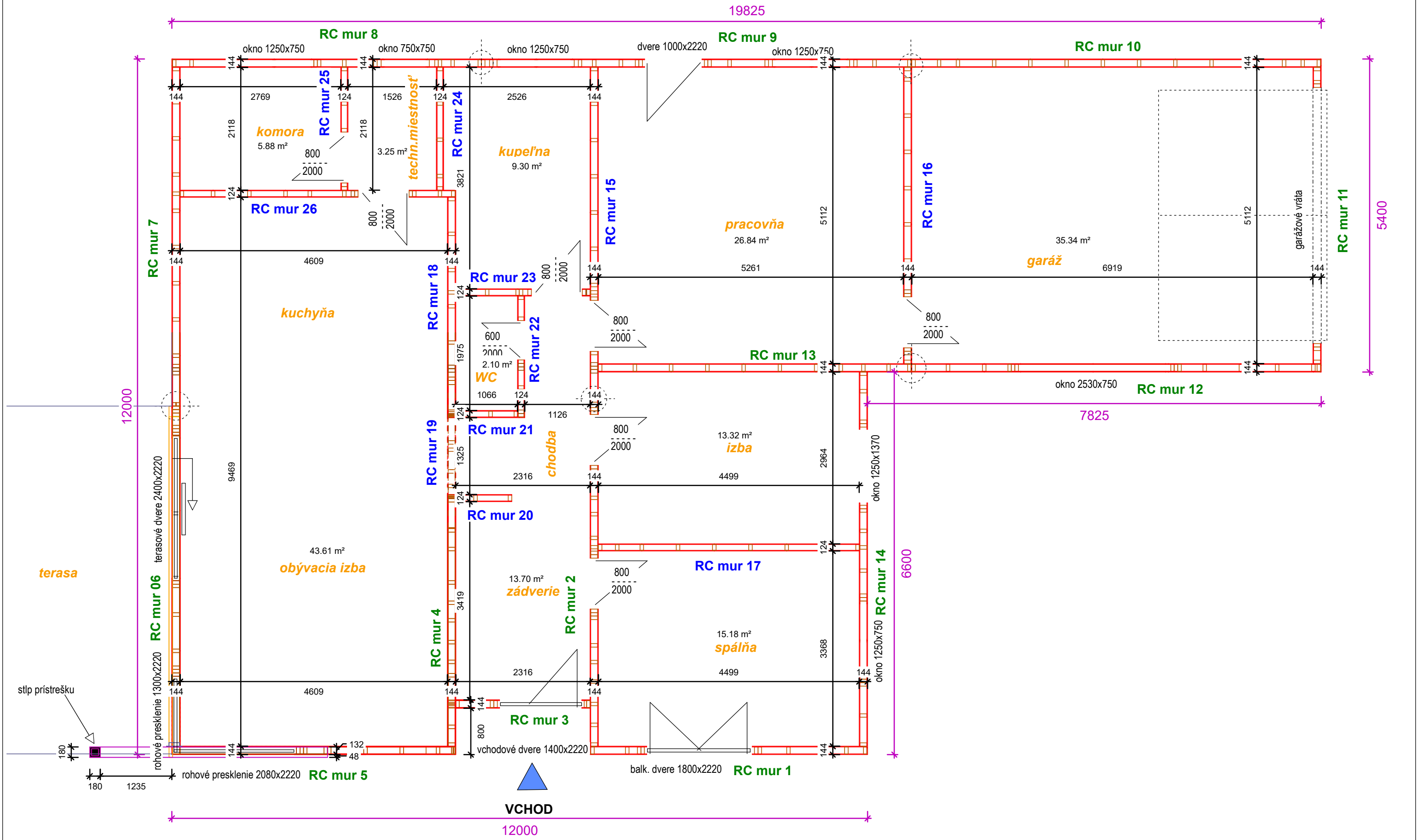

184.47 m²

A	13-10-2017		CM
indice	date	modifications	nom

Projet: RD Zábojníkovci	Carnet: 060 (plancad n° 060)	Echelle: 1/10°
Maitre d'ouvrage:	Chargé d'Affaire:	N° d'affaire:
Nom du plan: rozloženie panelov prizemia		
Dessinateur:		

množstvá kovaní sú uvedené v sumárnej tabuľke (excel)

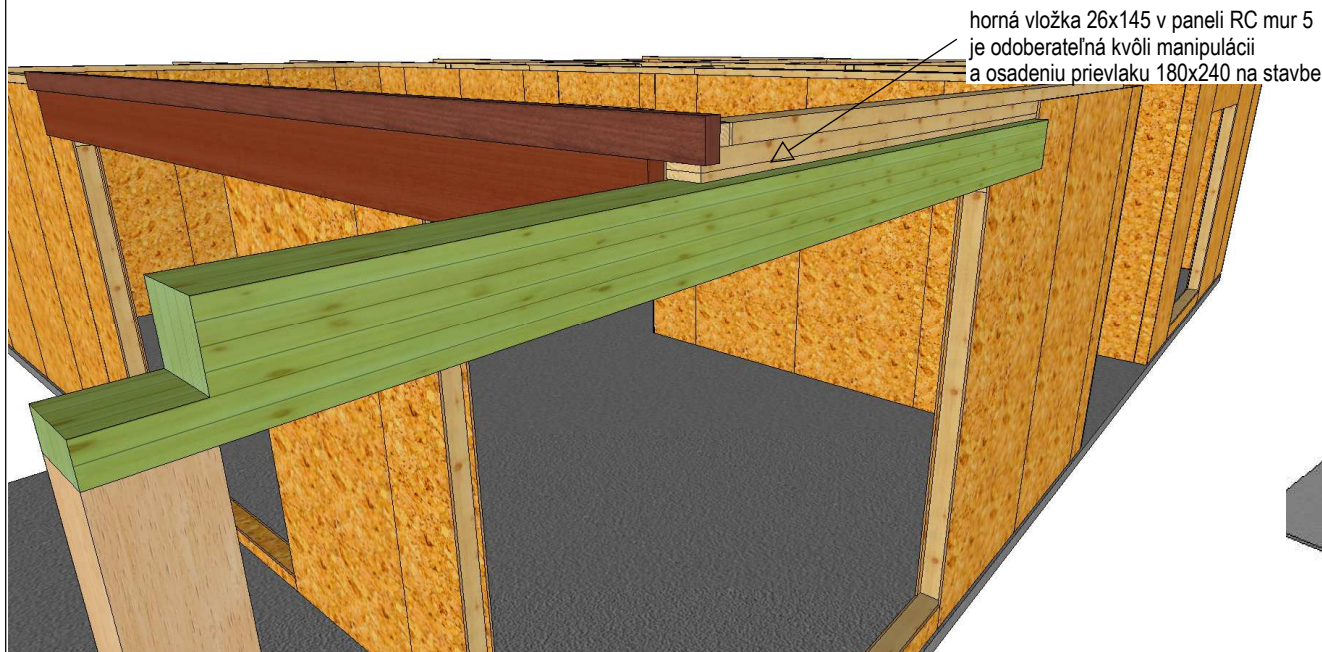

horná vložka 26x145 v paneli RC mur 5
je odoberateľná kvôli manipulácii
a osadeniu prievlaku 180x240 na stavbe

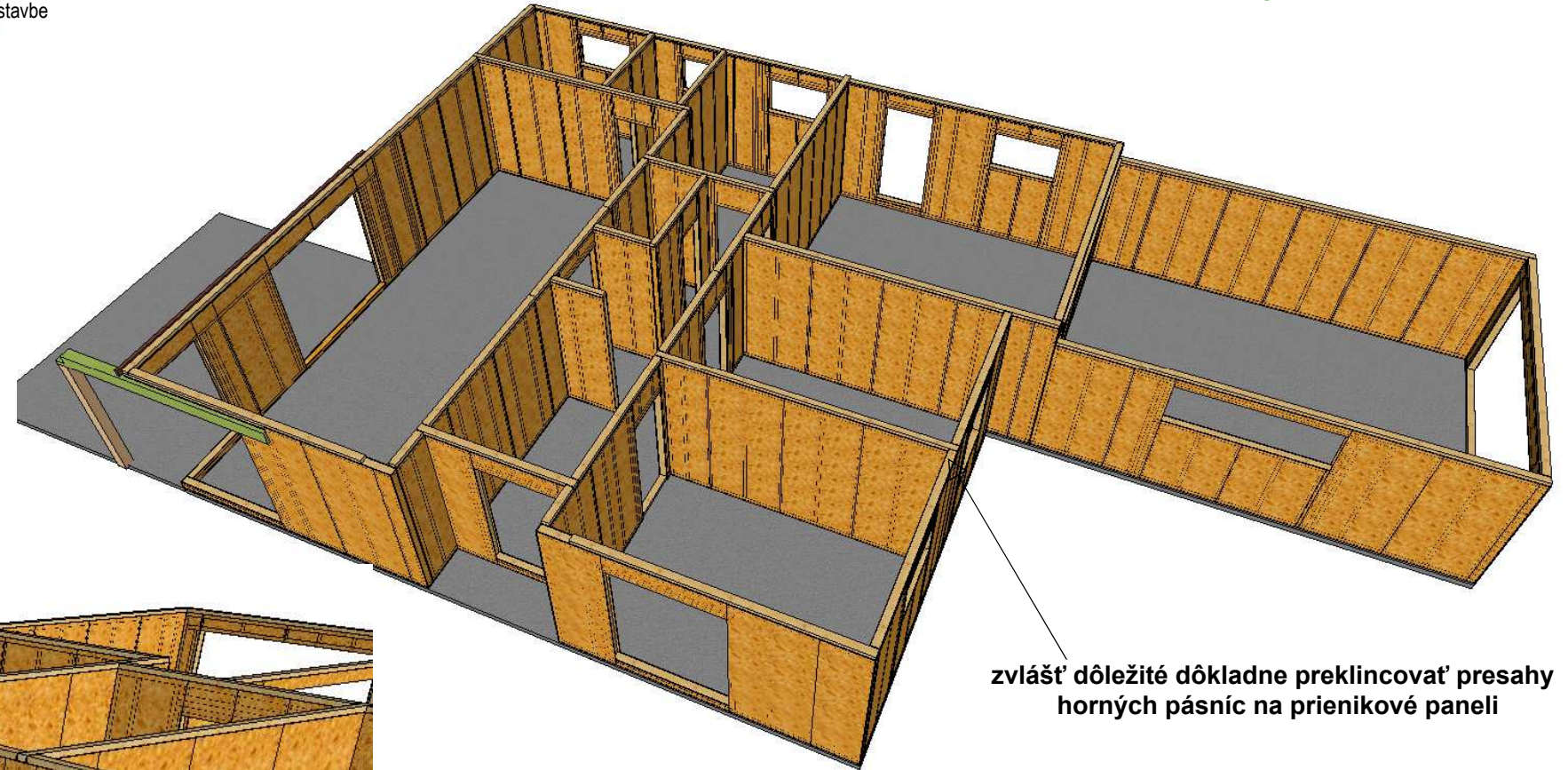

**zvlášť dôležité dôkladne preklincovať presahy
horných pásnic na prienikové paneli**

panel RC mur 19

preklincovať a preskrutkovať
zboku cez OSB dosky

spoj 2 kolmých prievlakov na trámovú papuču-na stavbe

použiť na fixovanie 2ks + 2ks
skrutiek so 6hr.hlavou 10x120
+ hrebienkové klnice 4x50

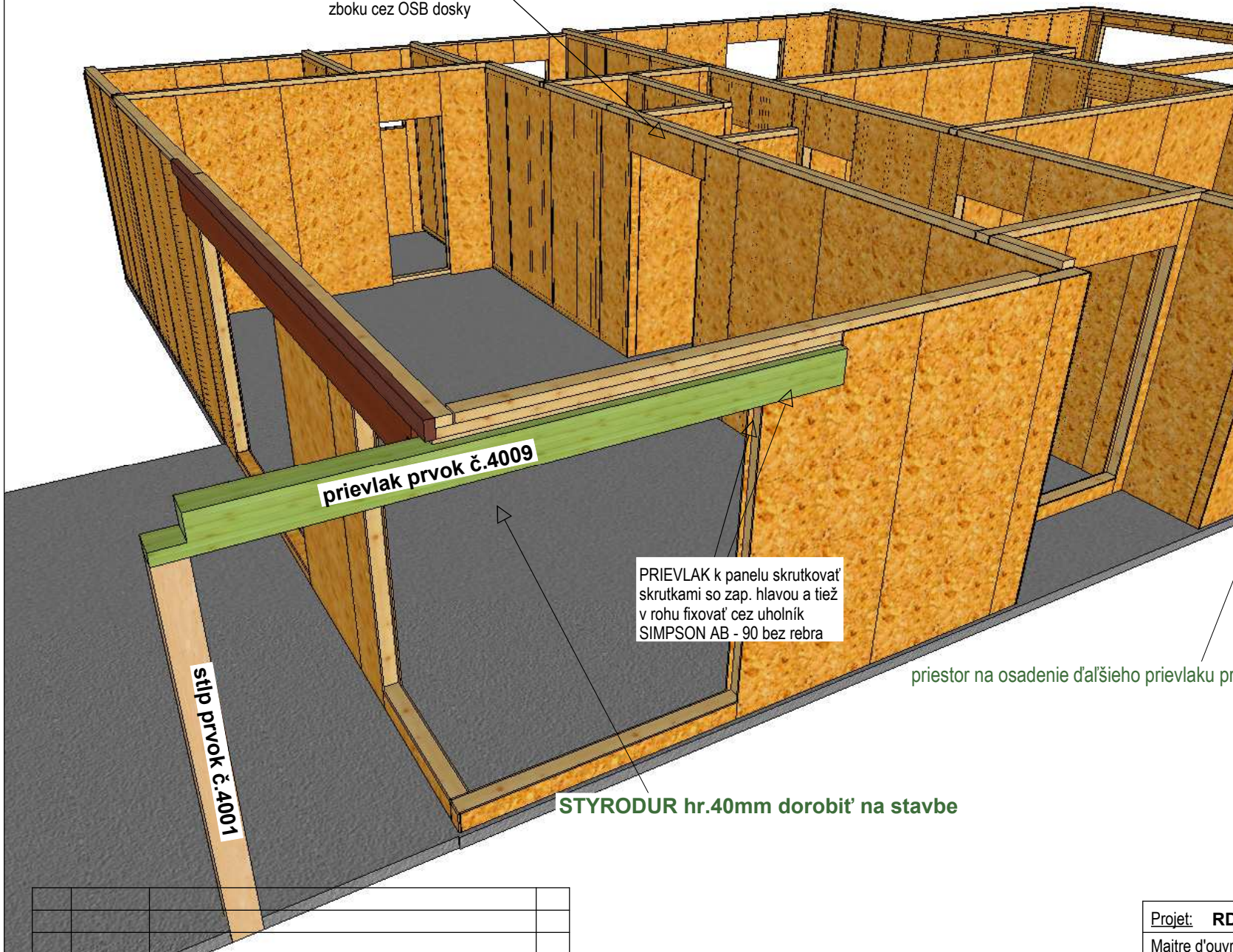

prievlak prvok č.4009

PRIEVLAK k panelu skrutkovať
skrutkami so zap. hlavou a tiež
v rohu fixovať cez uholník
SIMPSON AB - 90 bez rebra

priestor na osadenie ďalšieho prievlaku prístrešku

STYRODUR hr.40mm dorobiť na stavbe

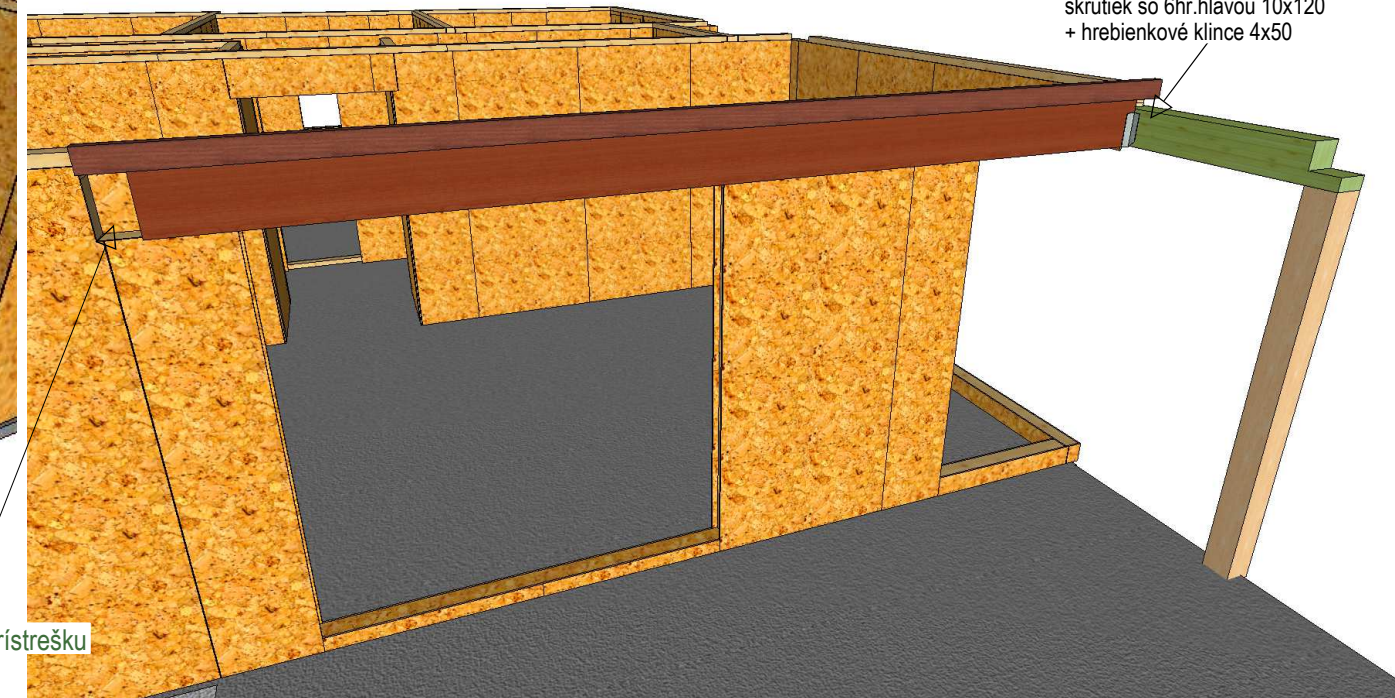

**Horné pásnice panelov ktoré sú v príbale
klnicovať na stavbe - zvlášť dôležité
preklincovať kolmé spoje panelov**

klnicovať hl. stav. klnicami 4x120

indice	date	modifications	nom
A	13-10-2017		CM

Projet: RD Zábojníkovci	Carnet: 09-065 (plancad n° 065)	Echelle: 1/10°
Maitre d'ouvrage:	Chargé d'Affaire:	N° d'affaire:
Nom du plan: montáž prizemia		
Dessinateur:		

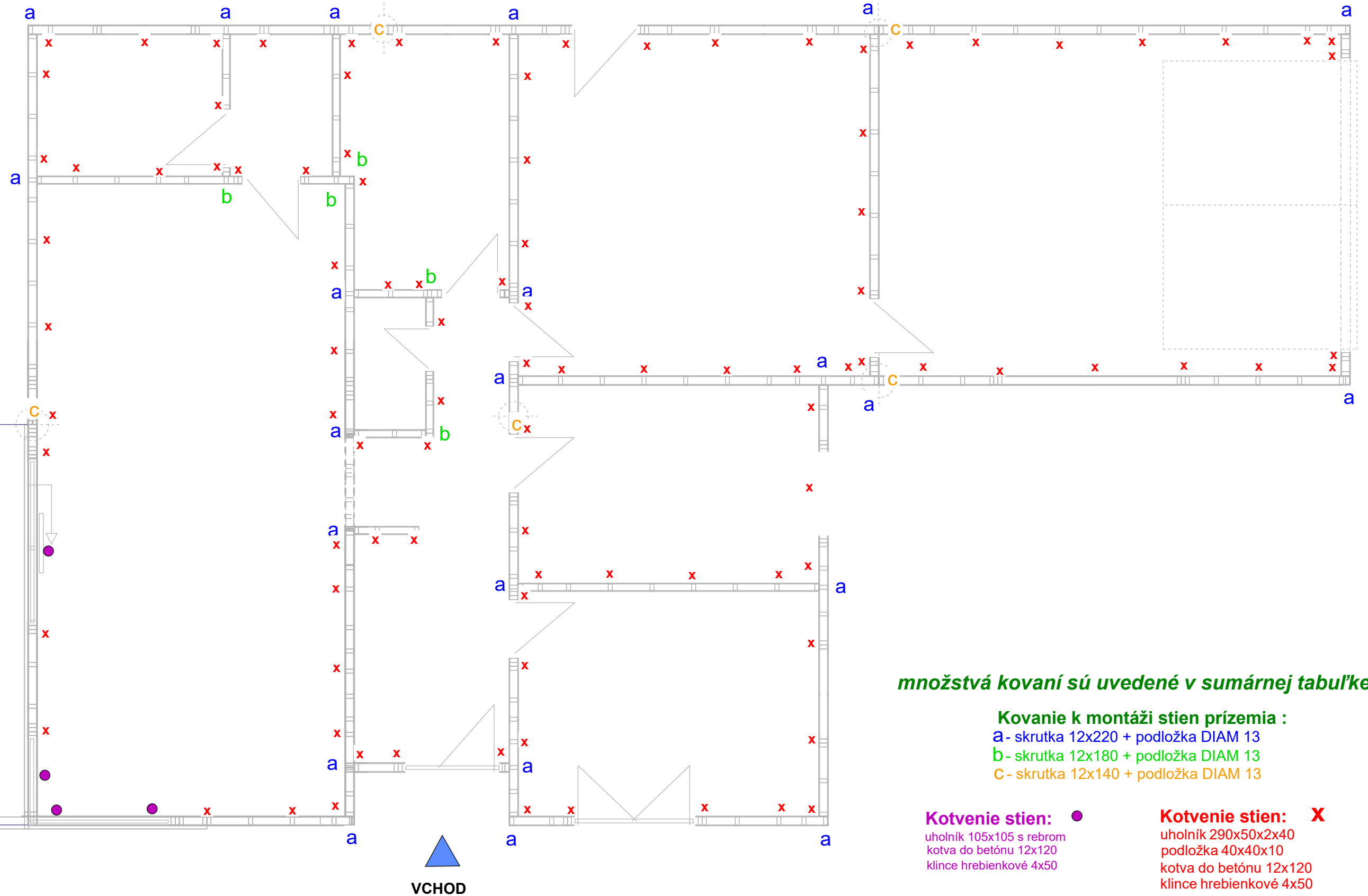

množstvá kovaní sú uvedené v sumárnej tabuľke (excel)

Kovanie k montáži stien prízemia :

a - skrutka 12x220 + podložka DIAM 13

b - skrutka 12x180 + podložka DIAM 13

c - skrutka 12x140 + podložka DIAM 13

Kotvenie stien:

●
uholník 105x105 s rebrom
kotva do betónu 12x120
klince hrebenkové 4x50

Kotvenie stien: X

uholník 290x50x2x40
podložka 40x40x10
kotva do betónu 12x120
klince hrebenkové 4x50

Montážne kovanie a spoj. prvky k prízemiu = pozri tiež plán č.065

A	13-10-2017		CM
indice	date	modifications	nom

Projet: RD Zábojníkovci	Carnet: 070 (plancad n° 070)	Echelle: 1/10°
Maitre d'ouvrage:	Chargé d'Affaire:	N° d'affaire:
Nom du plan: montážne kovanie prízemia		
Dessinateur:		

RC 0
Mur 1
PLAN : -1, 0, 1
N° courant (C)
Echelle: 1 : 20

60 x 120
C4 : 4763 2x
C5 : 1900 1x
C6 : 2020 2x
C7 : 4263 1x
C126: 2659 6x
C127: 2390 2x
C128: 149 4x
120 x 60
C125: 2659 2x

60x120

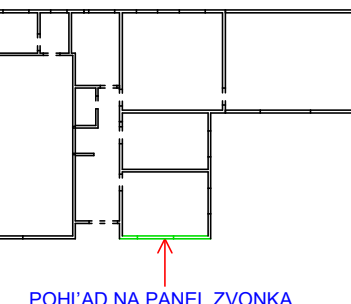
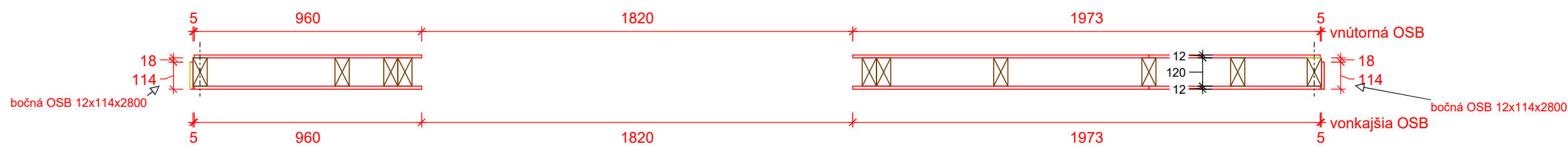
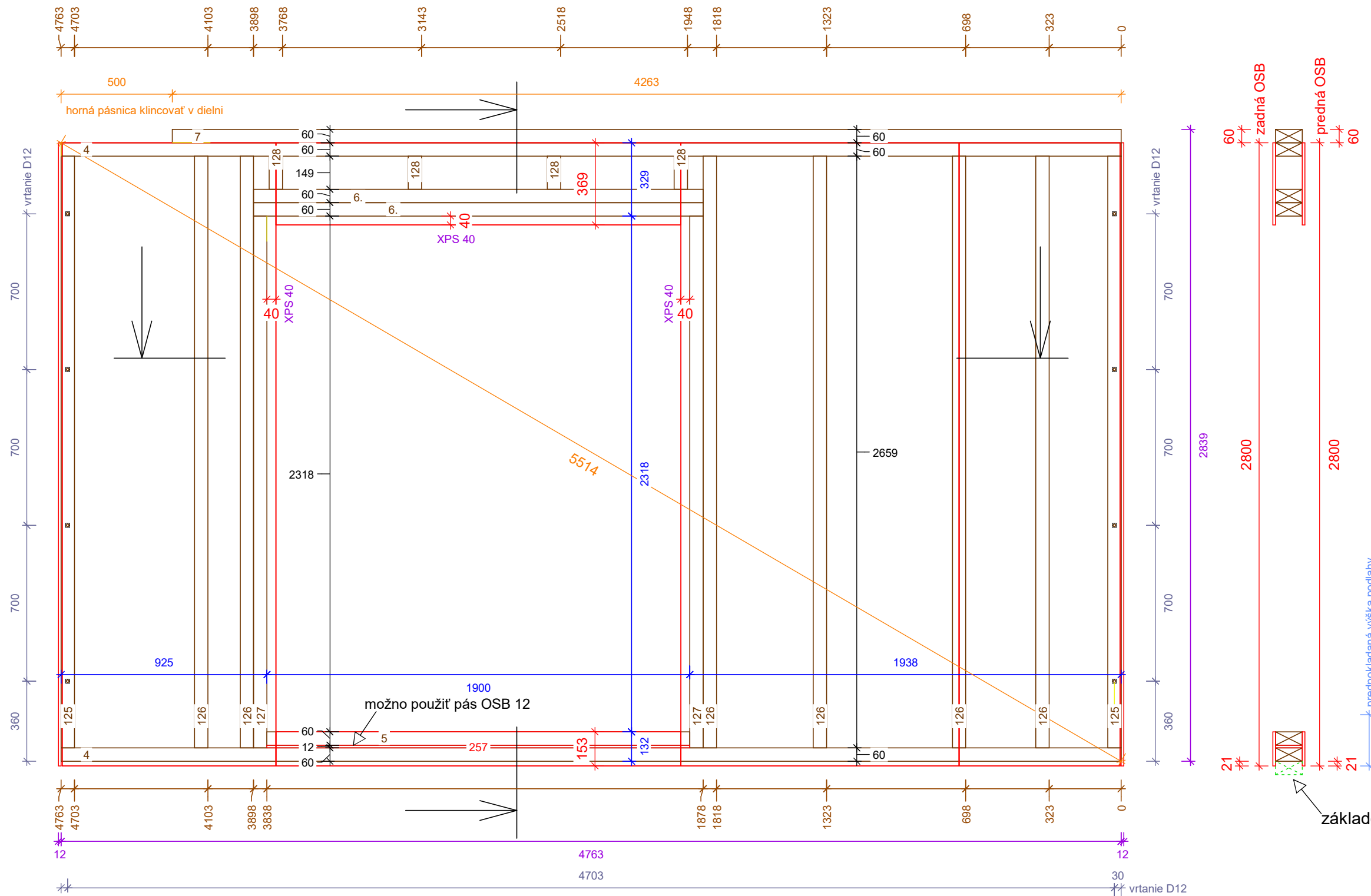

POHLAD NA PANEL ZVONKA

indice	date	modifications	nom
A	04-10-2017		CM

Projet: RD Zábojníkovci	Carnet: 09-101 (placnad n° 101)	Echelle: 1 : 20
Maitre d'ouvrage:	Chargé d'Affaire:	N° d'affaire:
Nom du plan: RC Mur 01		
Dessinateur:		

RC 0
Mur 2
PLAN : -1, 0, 1
N° courant (C)
Echelle: 1 : 22

60 x 120		
C9 :	5993	2x
C10 :	1210	1x
C11 :	1158	1x
C12 :	2003	1x
C13 :	2572	1x
C14 :	658	1x
C126 :	2659	11x
C129 :	2150	8x
C130 :	389	8x
C242 :	1210	1x
C243 :	1158	1x
120 x 60		
C125 :	2659	2x

60x120

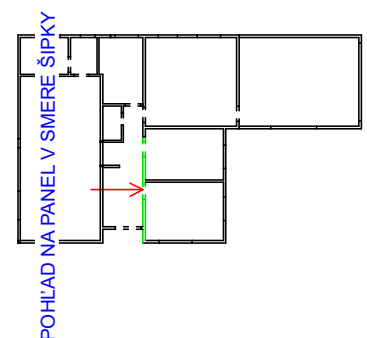
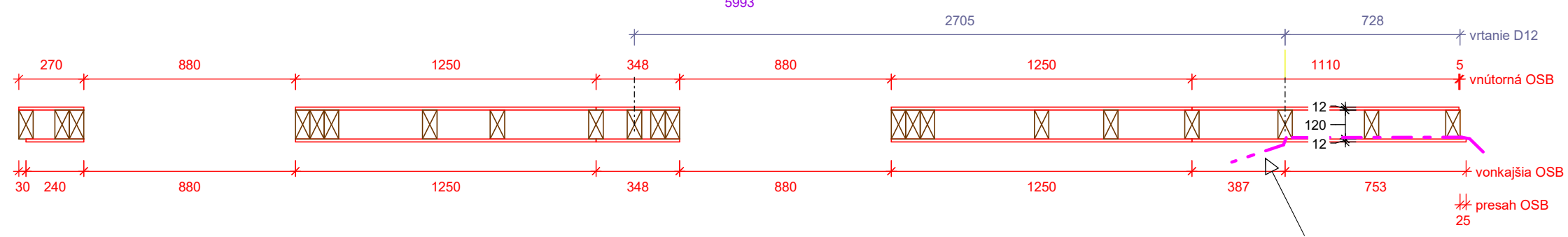
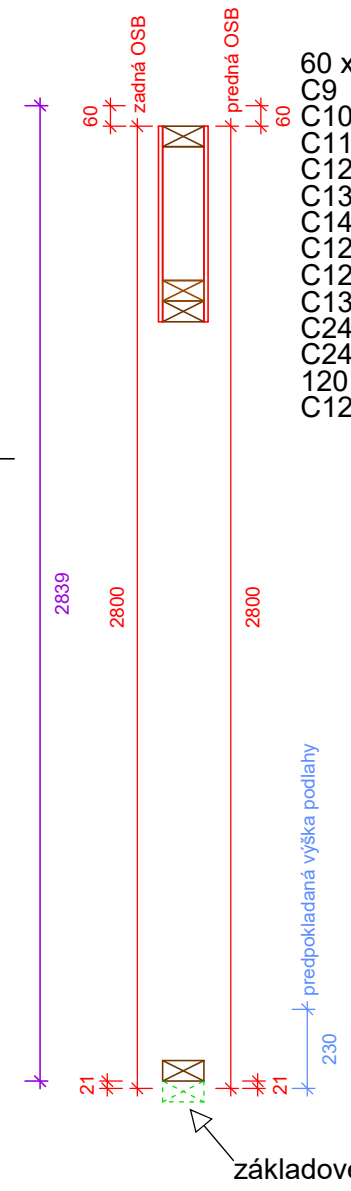
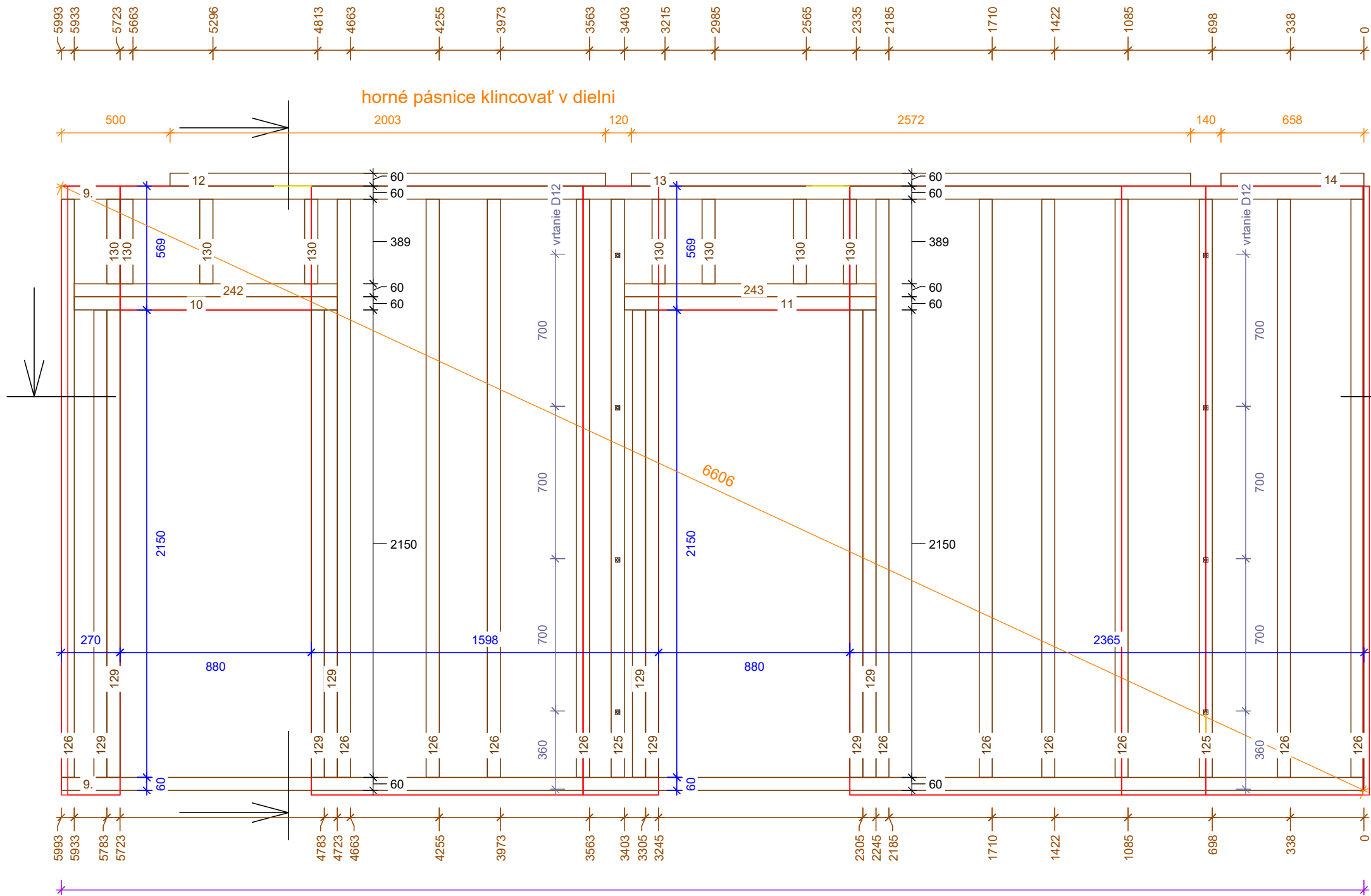

A	04-10-2017		CM
indice	date	modifications	nom

Projet: RD Zábojníkovci	Carnet: 09-102 (placnad n° 102)	Echelle: 1 : 22
Maitre d'ouvrage:	Chargé d'Affaire:	N° d'affaire:
Nom du plan: RC Mur 02		
Dessinateur:		

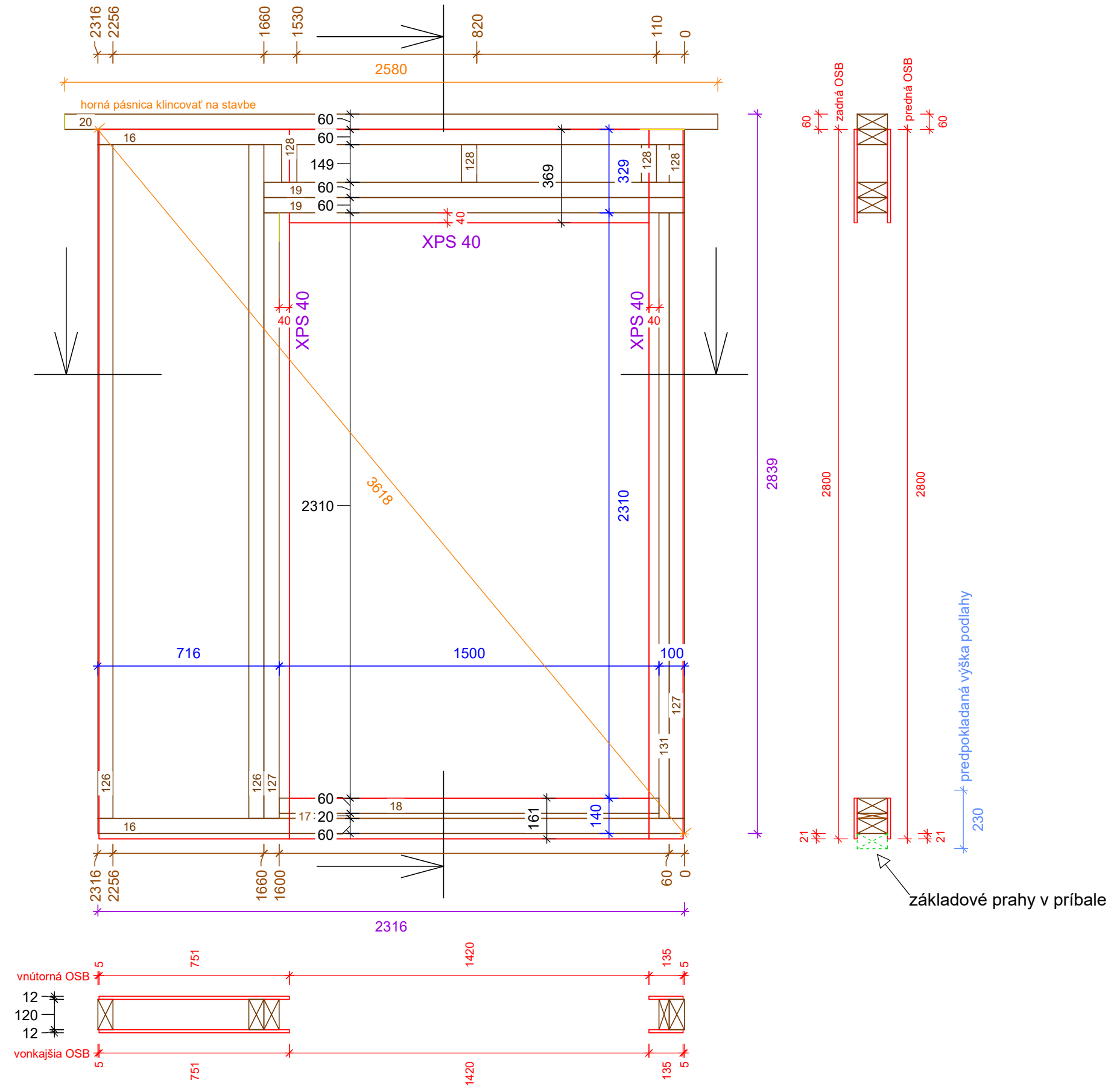

RC 0
 Mur 3
 PLAN : -1, 0, 1
 N° courant (C)
 Echelle: 1 : 18

- 20 x 120
- C17 : 1500 1x
- 40 x 120
- C131: 2390 1x
- 60 x 120
- C16 : 2316 2x
- C18 : 1500 1x
- C19 : 1660 2x
- C20 : 2580 1x
- C126: 2659 2x
- C127: 2390 2x
- C128: 149 4x

60x120

A	04-10-2017		CM
indice	date	modifications	nom

Projet: RD Zábojníkovci	Carnet: 09-103 (plancad n° 103)	Echelle: 1 : 18
Maitre d'ouvrage:	Chargé d'Affaire:	N° d'affaire:
Nom du plan: RC Mur 03		
Dessinateur:		

RC 0
Mur 4
PLAN : -1, 0, 1
N° courant (C)
Echelle: 1 : 20

60 x 120
C14 : 658 1x
C22 : 4331 1x
C23 : 4271 1x
C24 : 2973 1x
C126: 2659 11x
120 x 60
C125: 2659 1x
C132: 2370 1x

60x120

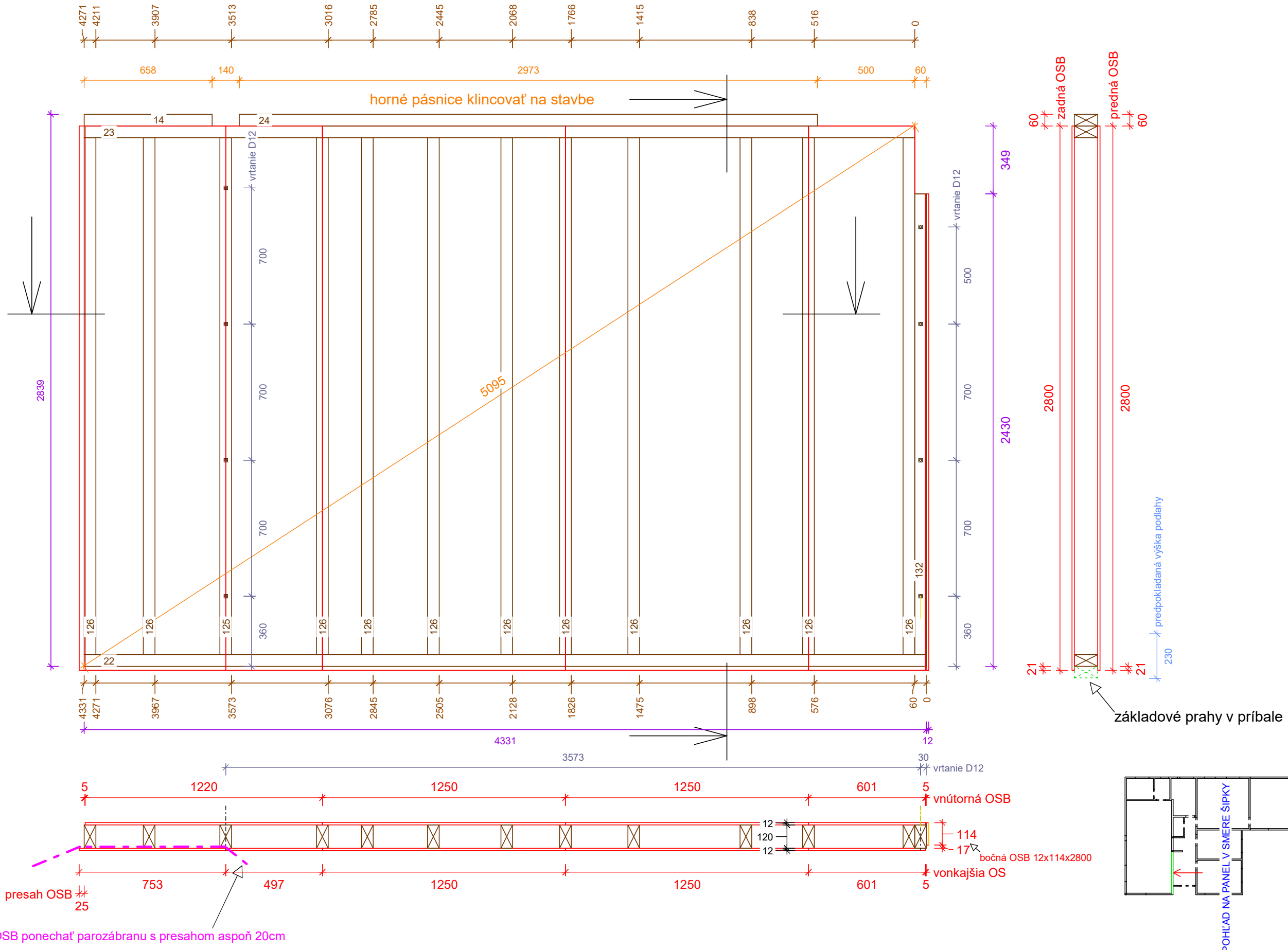

A	04-10-2017		CM
indice	date	modifications	nom

Projet: RD Zábojníkovci	Carnet: 09-104 (placnad n° 104)	Echelle: 1 : 20
Maitre d'ouvrage:	Chargé d'Affaire:	N° d'affaire:
Nom du plan: RC Mur 04		
Dessinateur:		

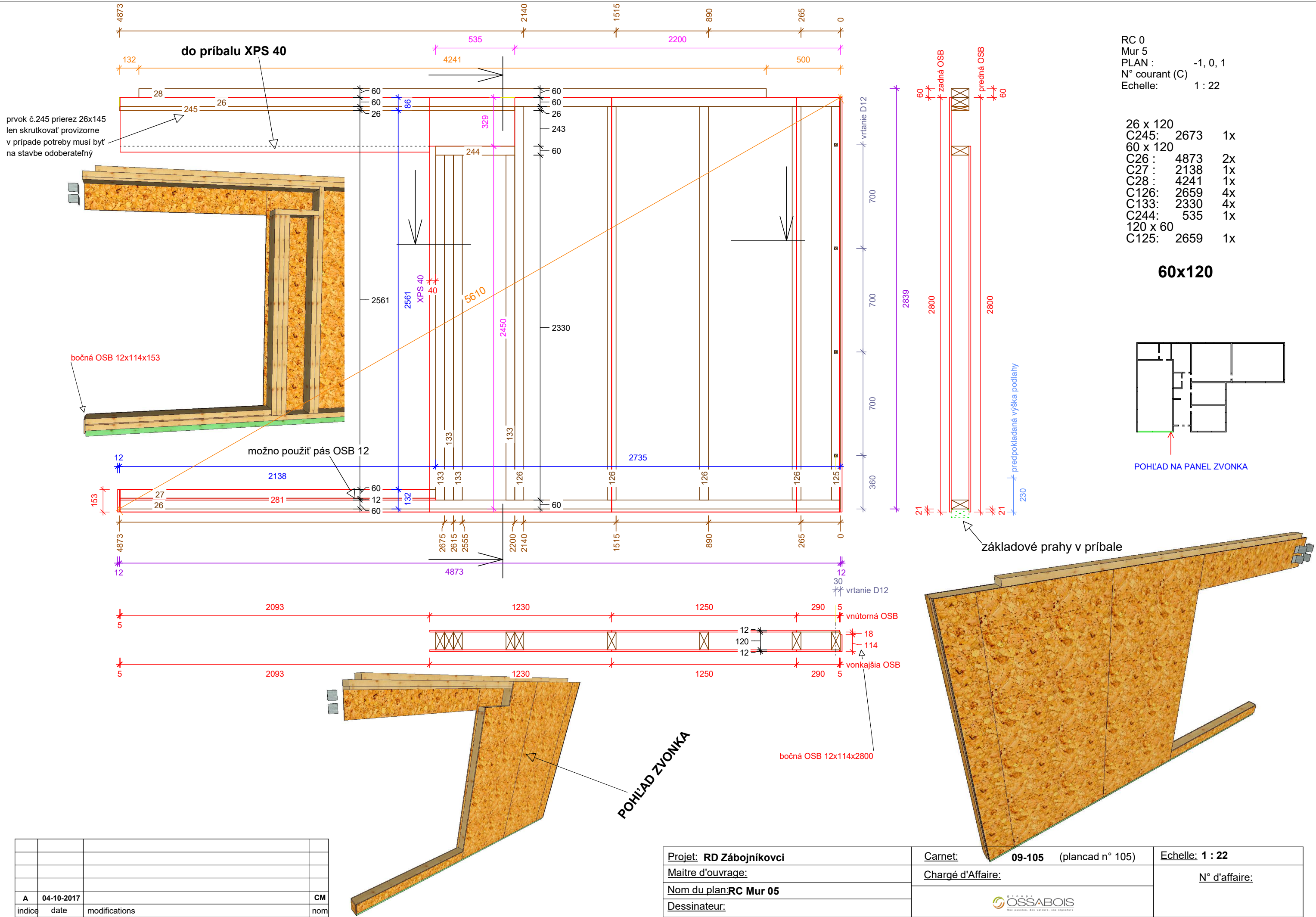

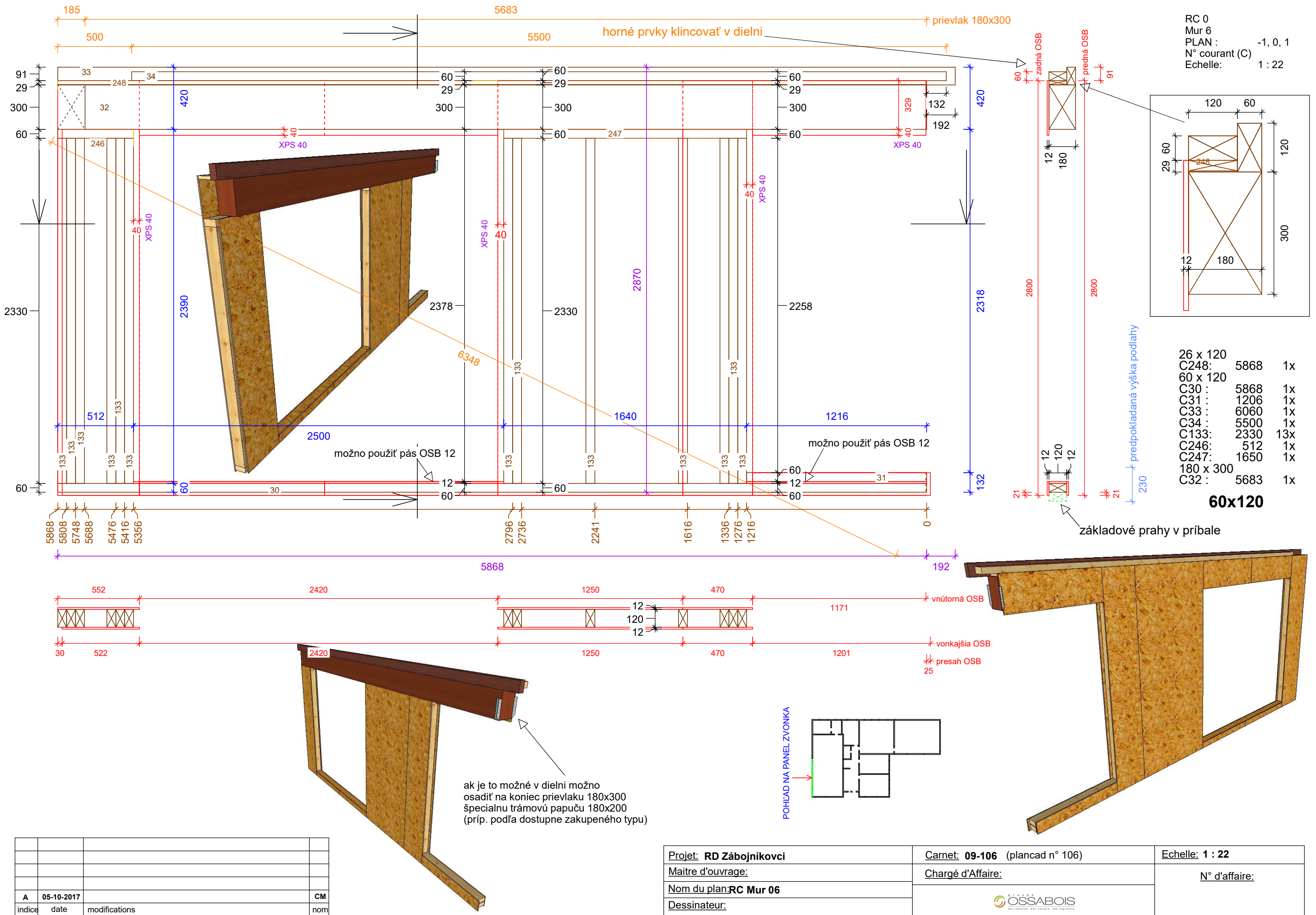

A	05-10-2017		CM
indice	date	modifications	nom

Projet: RD Zábojníkovci	Carnet: 09-106 (plancad n° 106)	Echelle: 1 : 22
Maitre d'ouvrage:	Chargé d'Affaire:	N° d'affaire:
Nom du plan: RC Mur 06		
Dessinateur:		



RC 0
Mur 7
PLAN : -1, 0, 1
N° courant (C)
Echelle: 1 : 22

60 x 120
C36 : 5844 2x
C37 : 2121 1x
C38 : 4103 1x
C126 : 2659 10x
C134 : 2659 2x
120 x 60
C125 : 2659 1x
C135 : 2659 1x

60x120

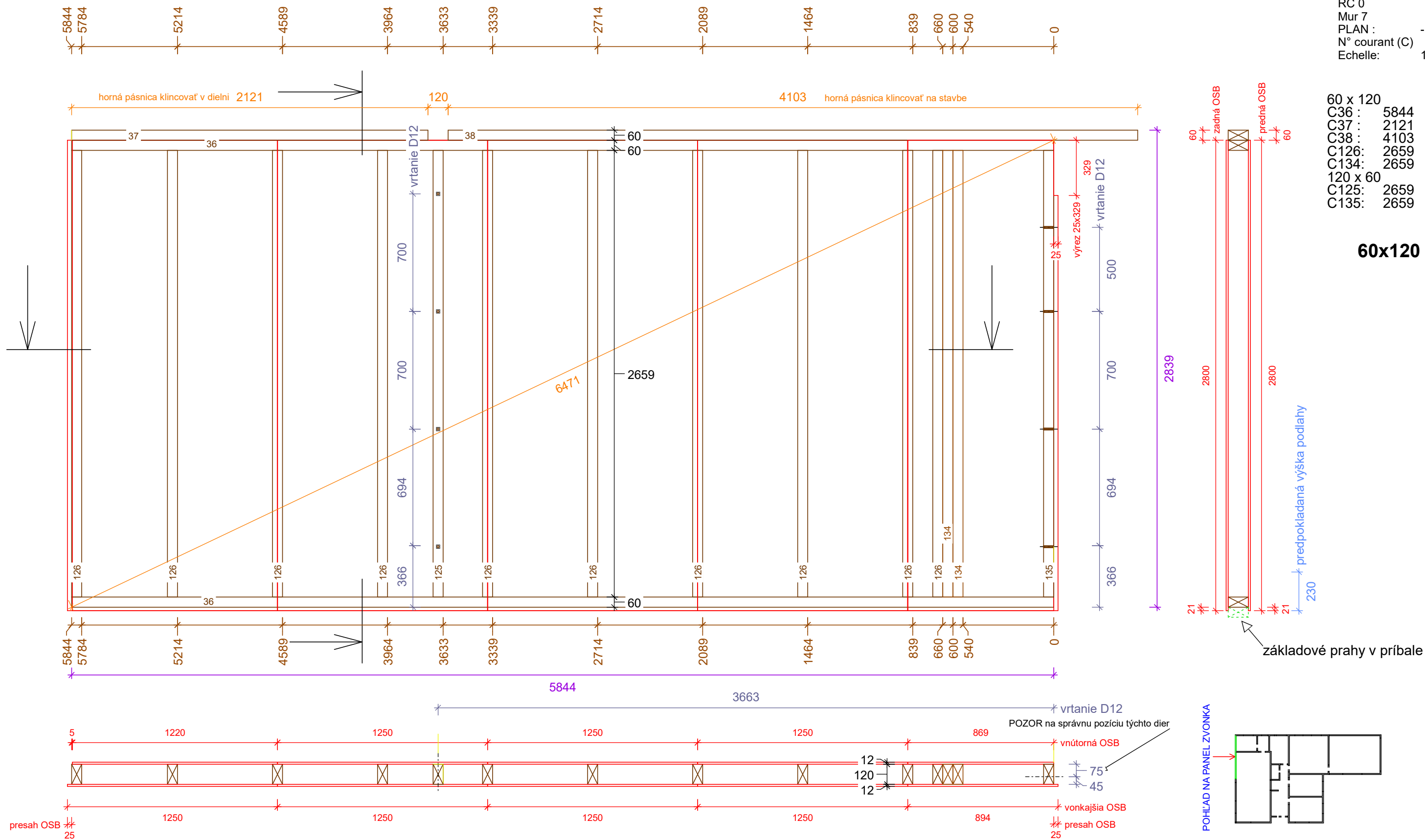

A	04-10-2017		CM
indice	date	modifications	nom

Projet: RD Zábojníkovci	Carnet: 09-107 (plancad n° 107)	Echelle: 1 : 22
Maitre d'ouvrage:	Chargé d'Affaire:	N° d'affaire:
Nom du plan: RC Mur 07		
Dessinateur:		

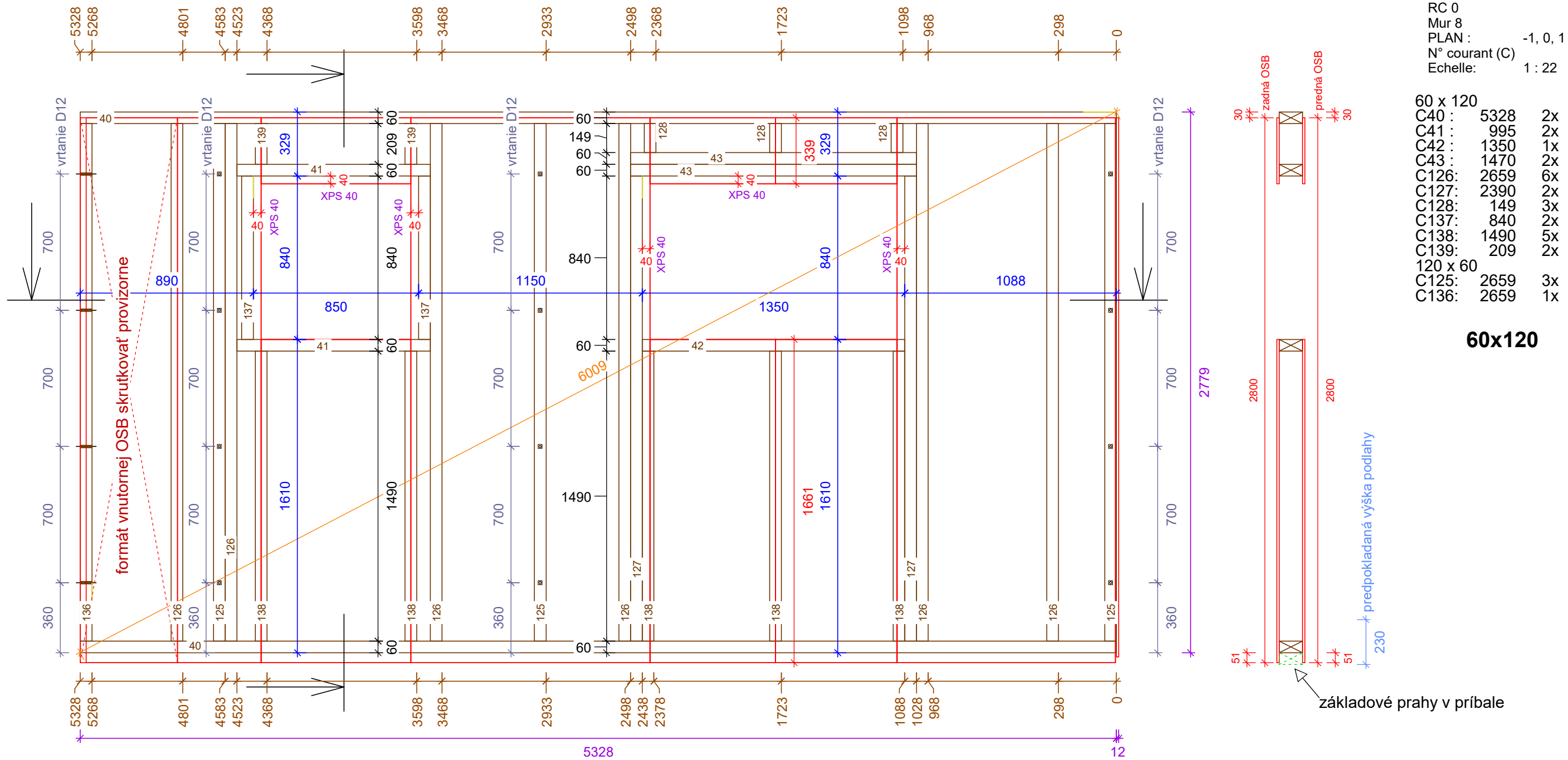

RC 0
Mur 8
PLAN : -1, 0, 1
N° courant (C) :
Echelle: 1 : 22

60 x 120		
C40 :	5328	2x
C41 :	995	2x
C42 :	1350	1x
C43 :	1470	2x
C126 :	2659	6x
C127 :	2390	2x
C128 :	149	3x
C137 :	840	2x
C138 :	1490	5x
C139 :	209	2x
120 x 60		
C125 :	2659	3x
C136 :	2659	1x

60x120

formát vnútornej OSB skrutkovať provizorne

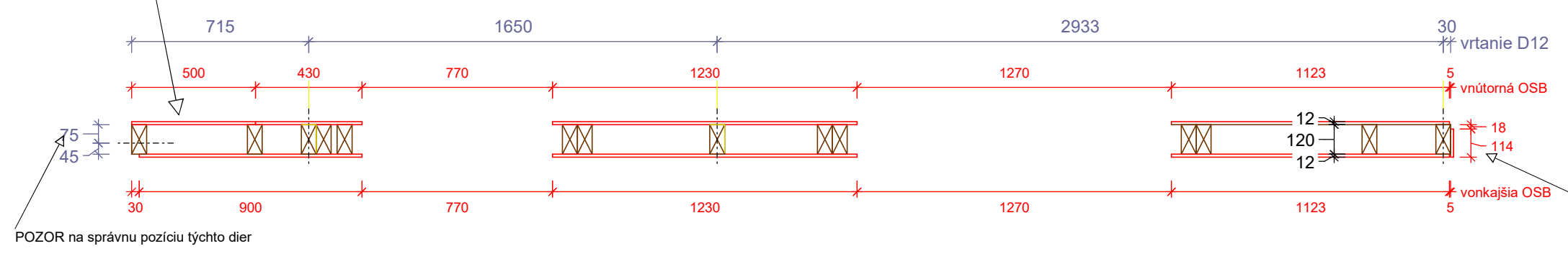

POHLAD NA PANEL ZVONKA

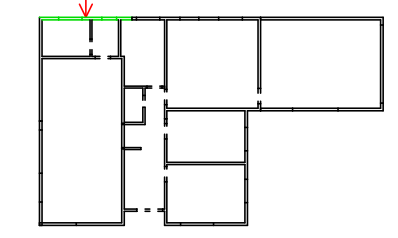

bočná OSB 12x114x2800

A	04-10-2017		CM
indice	date	modifications	nom

Projet: RD Zábojníkovci	Carnet: 09-108 (plancad n° 108)	Echelle: 1 : 22
Maitre d'ouvrage:	Chargé d'Affaire:	N° d'affaire:
Nom du plan: RC Mur 08		
Dessinateur:		

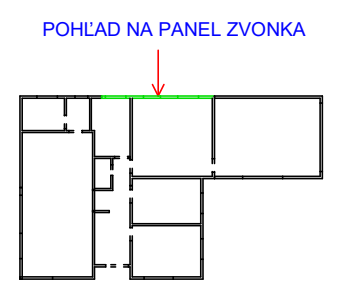
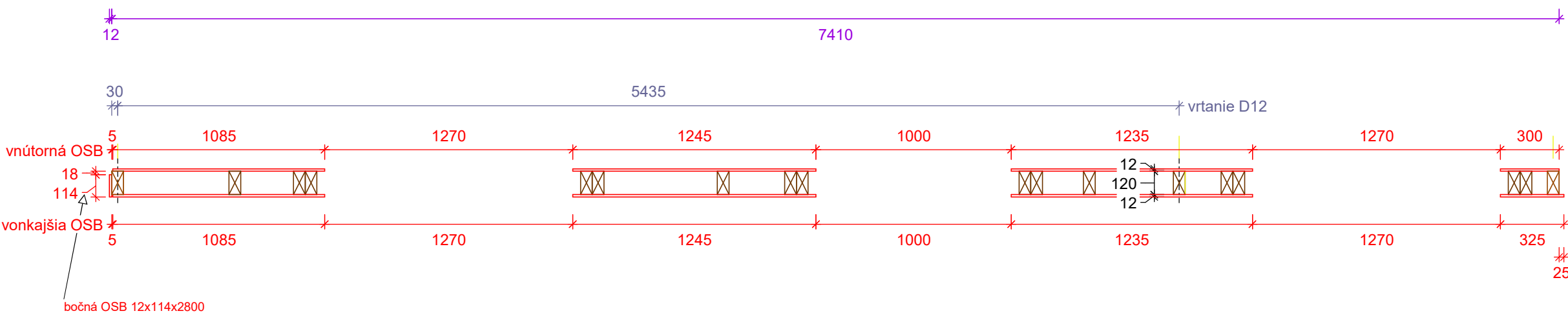
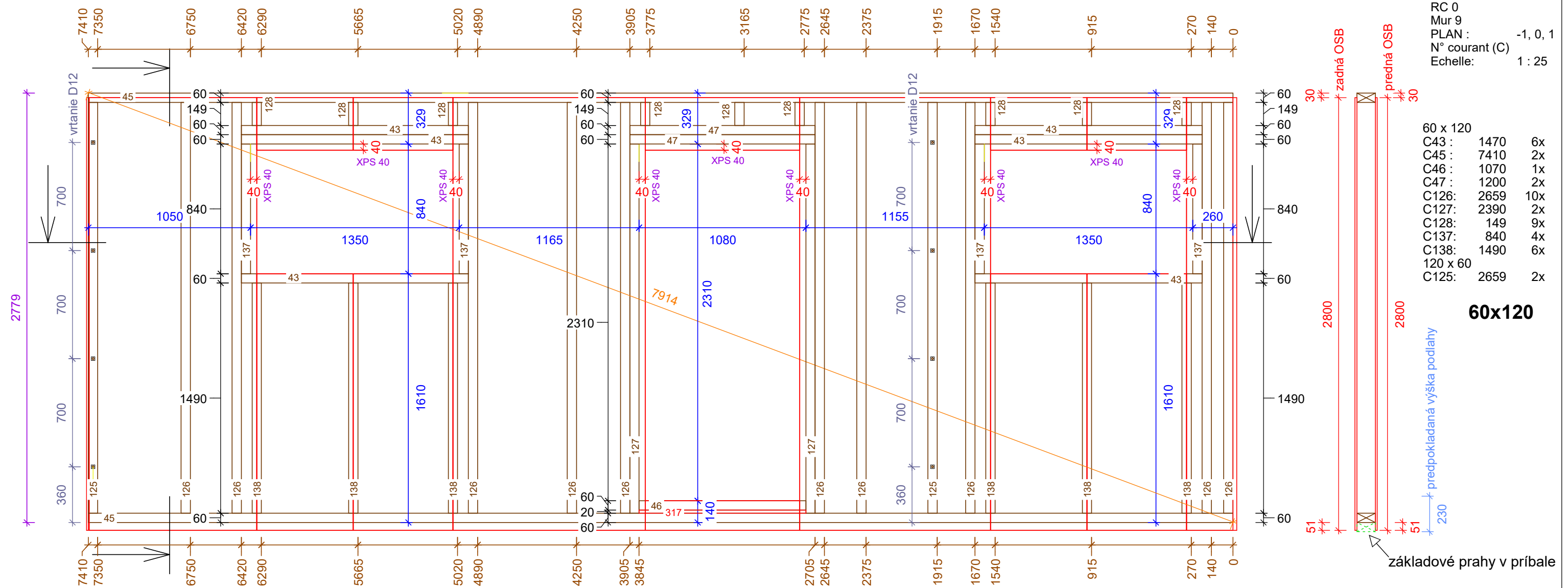

A	05-10-2017		CM
indice	date	modifications	nom

Projet: RD Zábojníkovci	Carnet: 09-109 (plancad n° 109)	Echelle: 1 : 25
Maitre d'ouvrage:	Chargé d'Affaire:	N° d'affaire:
Nom du plan: RC Mur 09		
Dessinateur:		

RC 0
Mur 10
PLAN : -1, 0, 1
N° courant (C)
Echelle: 1 : 25

60 x 120
C49 : 7051 3x
C141: 2299 12x
120 x 60
C140: 2299 1x
C142: 2299 1x

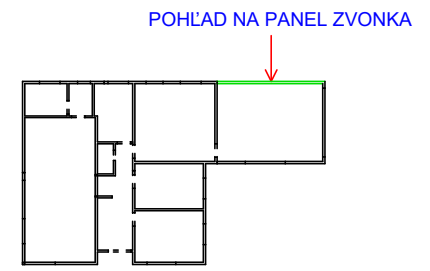
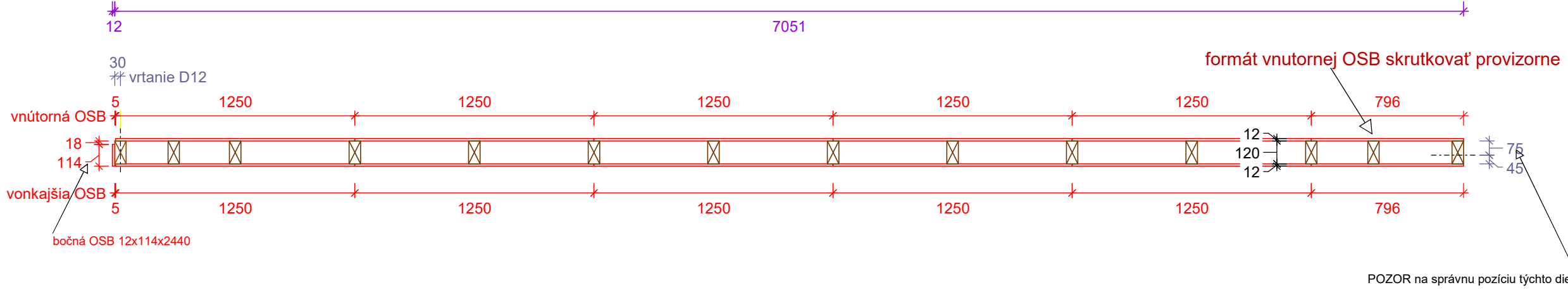
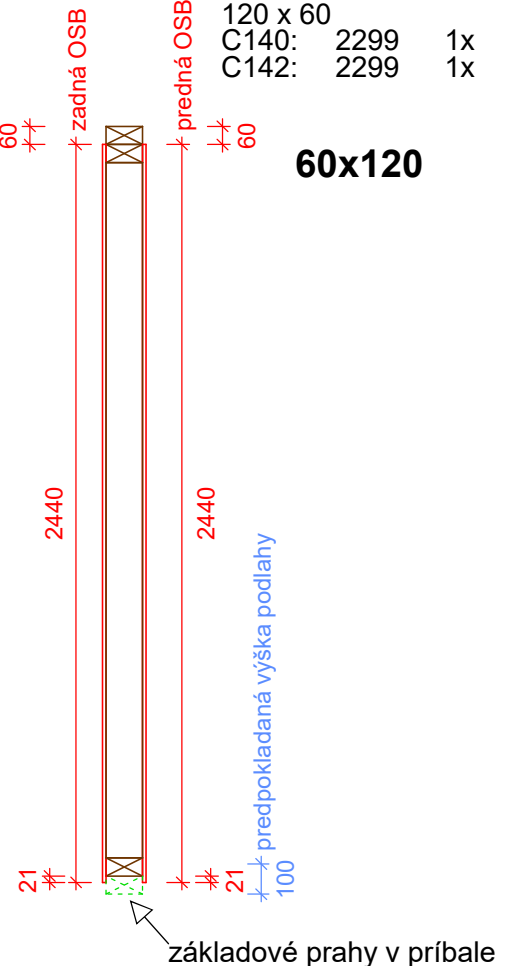
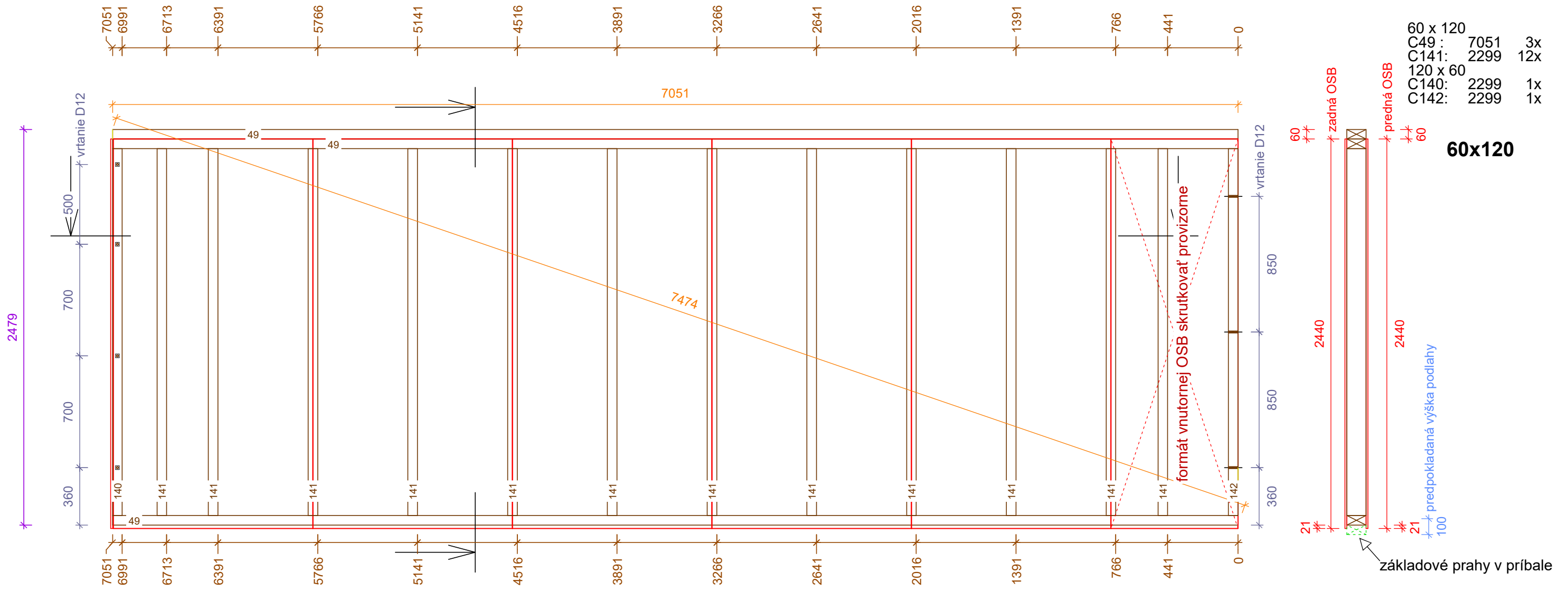

POZOR na správnú pozíciu týchto dier

A	04-10-2017		CM
indice	date	modifications	nom

Projet: RD Zábojníkovci	Carnet: 09-110 (placard n° 110)	Echelle: 1 : 25
Maitre d'ouvrage:	Chargé d'Affaire:	N° d'affaire:
Nom du plan: RC Mur 10		
Dessinateur:		

RC 0
 Mur 11
 PLAN : -1, 0, 1
 N° courant (C)
 Echelle: 1 : 20

60 x 120
 C51 : 5112 3x
 C52 : 4992 2x
 C141: 2299 2x
 C143: 2100 4x
 C144: 579 7x

60x120

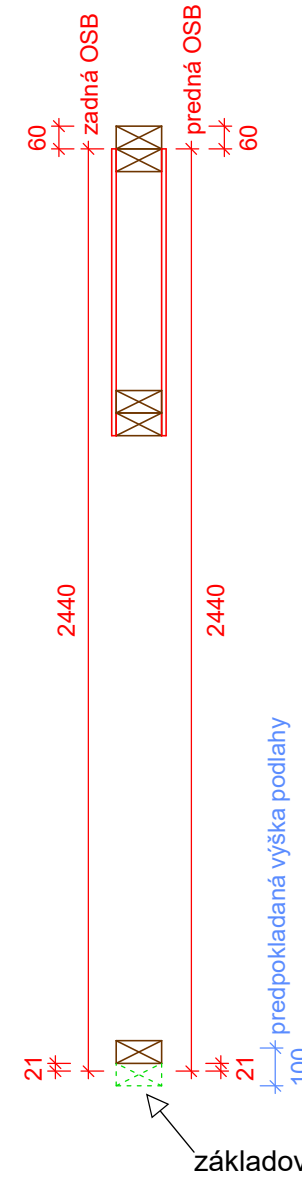
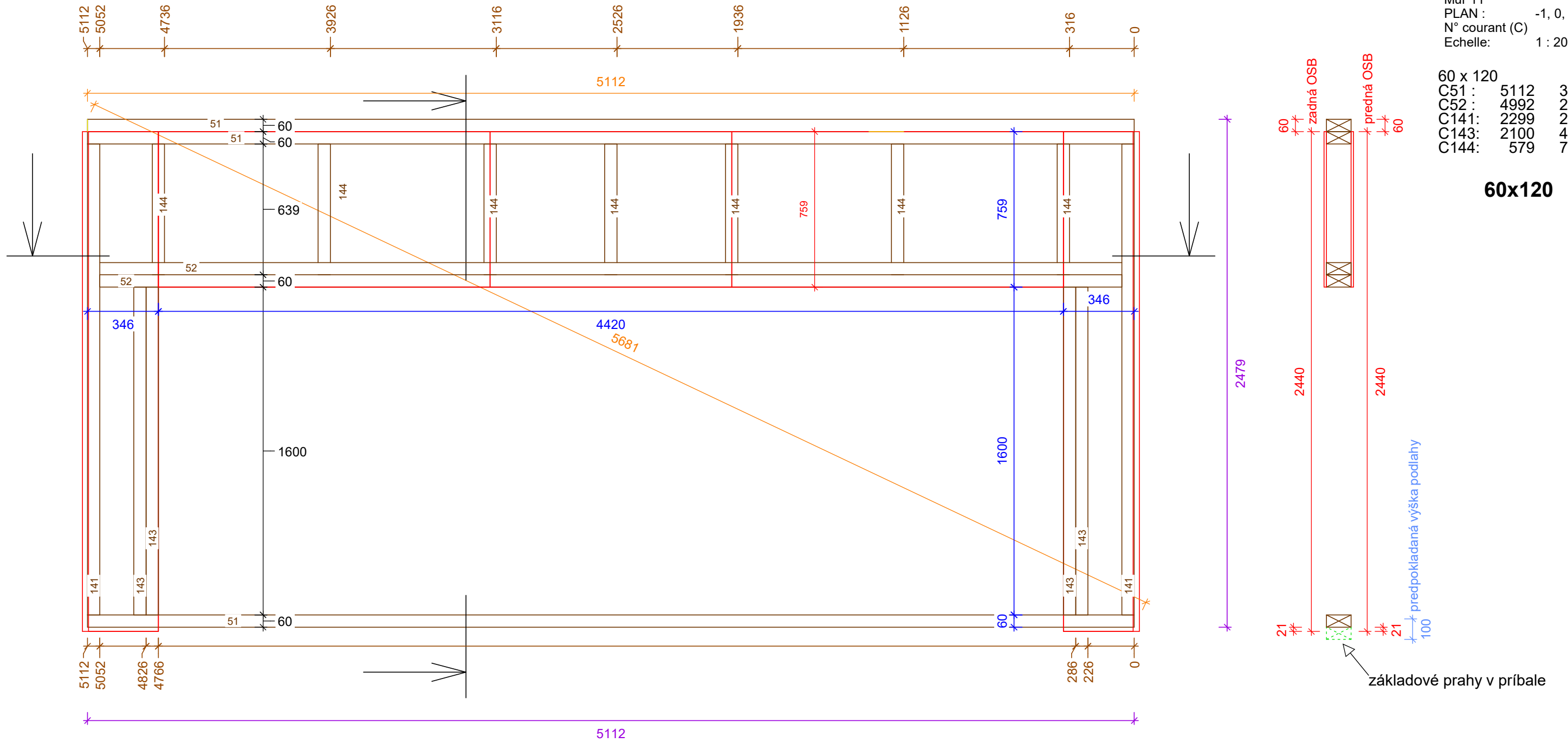

základové prahy v príbale

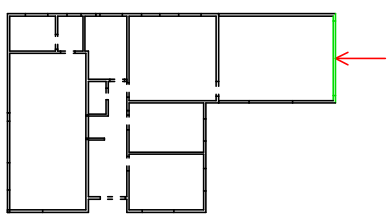
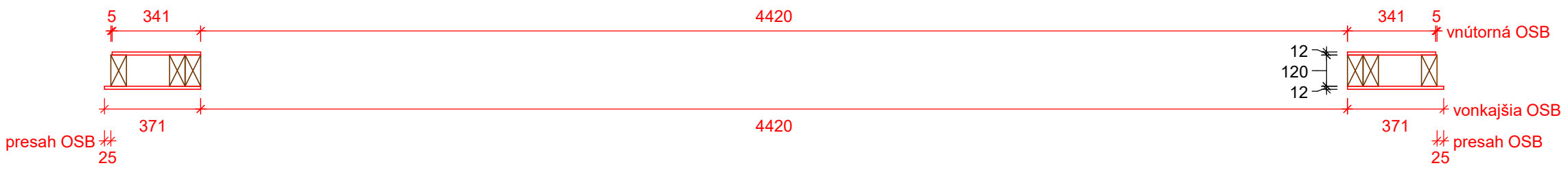

POHLAD NA PANEL ZVONKA

indice	date	modifications	nom
A	09-10-2017		CM

Projet: RD Zábojníkovci	Carnet: 09-111 (placad n° 111)	Echelle: 1 : 20
Maitre d'ouvrage:	Chargé d'Affaire:	N° d'affaire:
Nom du plan: RC Mur 11		
Dessinateur:		

RC 0
Mur 12
PLAN : -1, 0, 1
N° courant (C)
Echelle: 1 : 25

60 x 120
C49 : 7051 3x
C53 : 2750 1x
C137: 840 2x
C141: 2299 6x
C145: 1739 4x
C146: 839 5x
C487: 340 5x
120 x 60
C140: 2299 1x
C142: 2299 1x
60x220
C249: 3743 2x

60x120

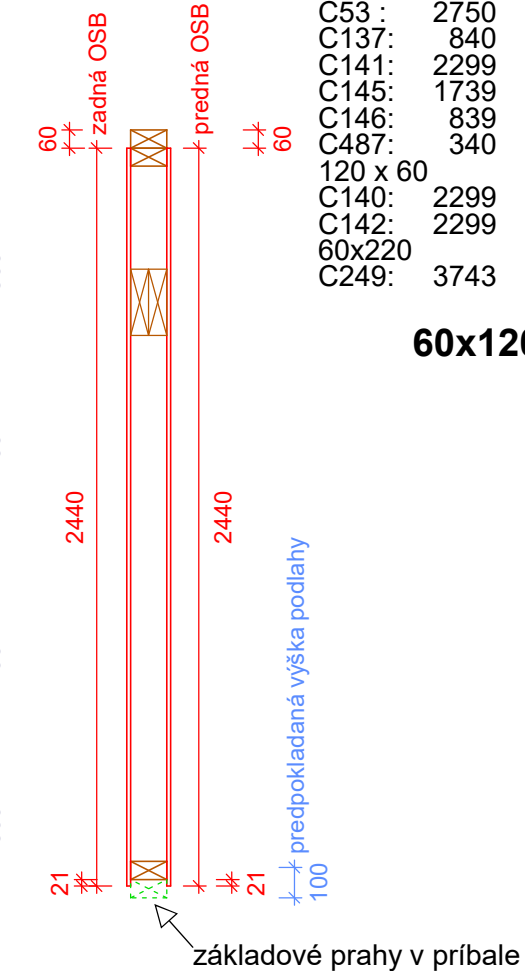
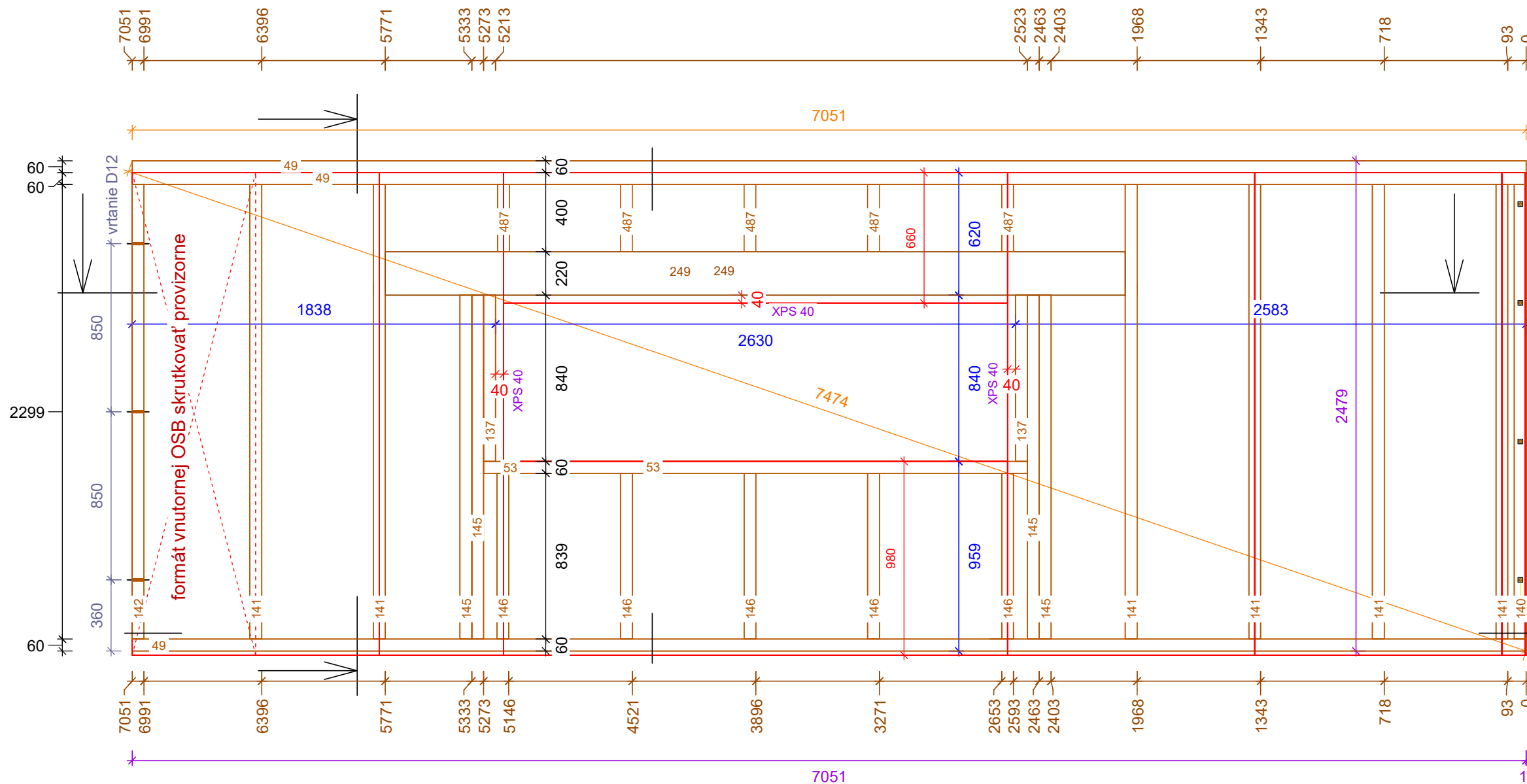

formát vnútornej OSB skrutkovať provizorne

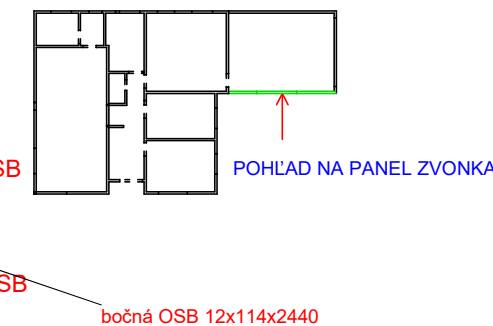
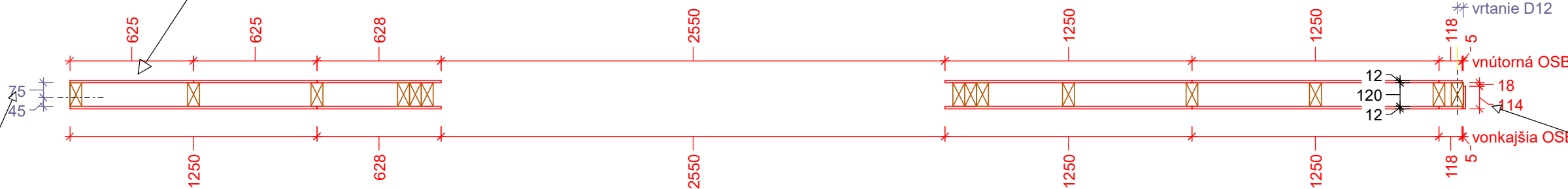

POZOR na správnu pozíciu týchto dier

A	12-10-2017		CM
indice	date	modifications	nom

Projet: RD Zábojníkovci	Carnet: 09-112 (plancad n° 112)	Echelle: 1 : 25
Maitre d'ouvrage:	Chargé d'Affaire:	N° d'affaire:
Nom du plan: RC Mur 12		
Dessinateur:		

RC 0
 Mur 13
 PLAN : -1, 0, 1
 N° courant (C)
 Echelle: 1 : 21

60 x 120
 C55 : 5393 3x
 C126 : 2659 10x
 120 x 60
 C125 : 2659 2x

60x120

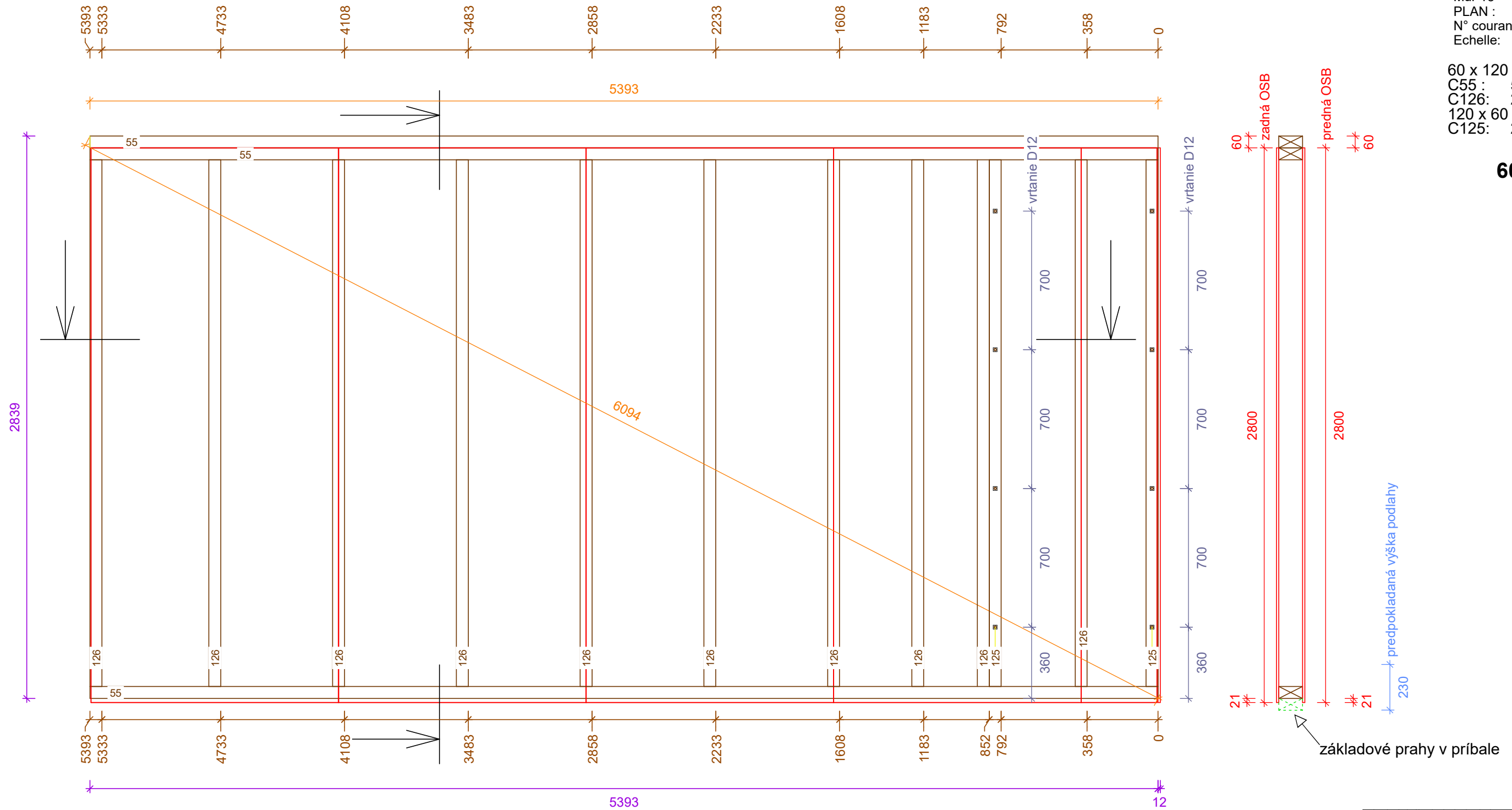

základové prahy v príbale

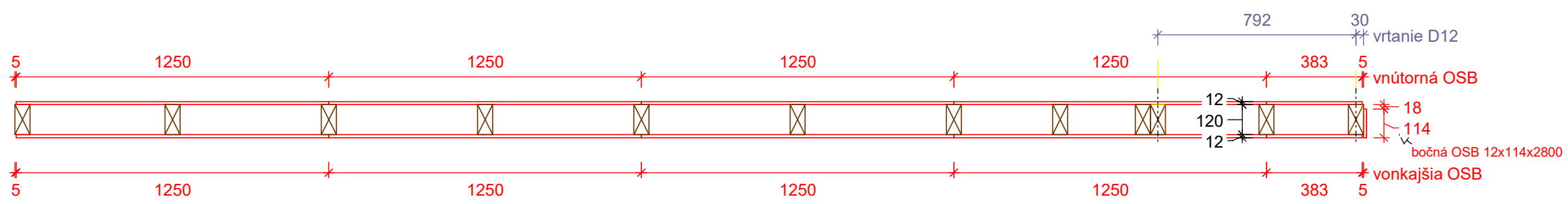
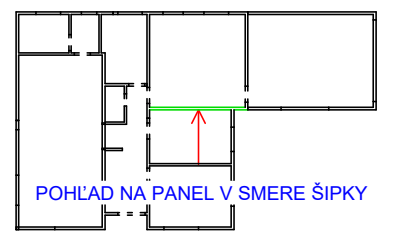

indice	date	modifications	nom
A	04-10-2017		CM

Projet: RD Zábojníkovci	Carnet: 09-113 (plancad n° 113)	Echelle: 1 : 21
Maitre d'ouvrage:	Chargé d'Affaire:	N° d'affaire:
Nom du plan: RC Mur 13		
Dessinateur:		

RC 0
 Mur 14
 PLAN : -1, 0, 1
 N° courant (C)
 Echelle: 1 : 23

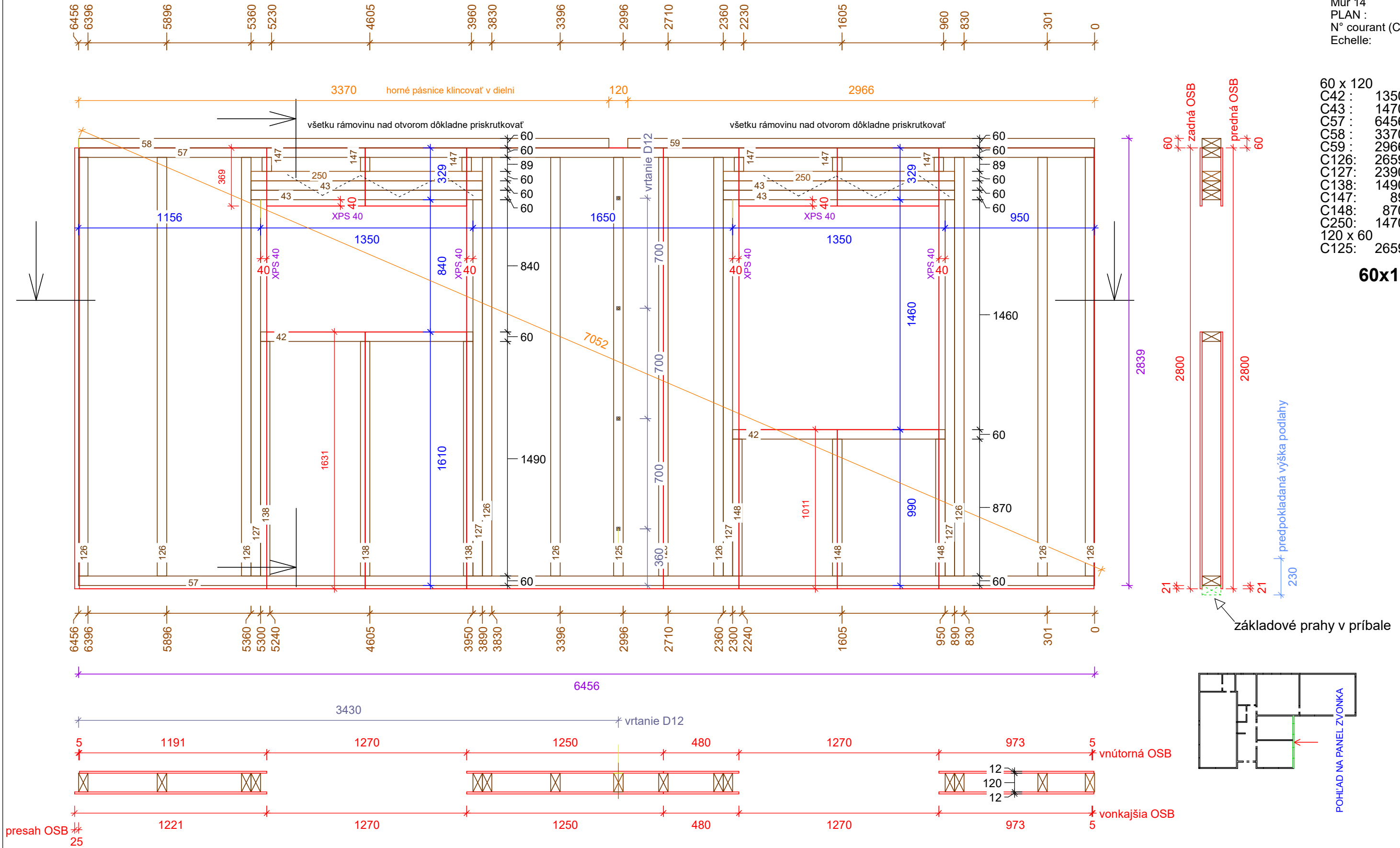

- 60 x 120**
- C42 : 1350 2x
 - C43 : 1470 4x
 - C57 : 6456 2x
 - C58 : 3370 1x
 - C59 : 2966 1x
 - C126: 2659 10x
 - C127: 2390 4x
 - C138: 1490 3x
 - C147: 89 6x
 - C148: 870 3x
 - C250: 1470 2x
 - 120 x 60
 - C125: 2659 1x

60x120

A	04-10-2017		CM
indice	date	modifications	nom

Projet: RD Zábojníkovci	Carnet: 09-114 (placád n° 114)	Echelle: 1 : 23
Maitre d'ouvrage:	Chargé d'Affaire:	N° d'affaire:
Nom du plan: RC Mur 14		
Dessinateur:		

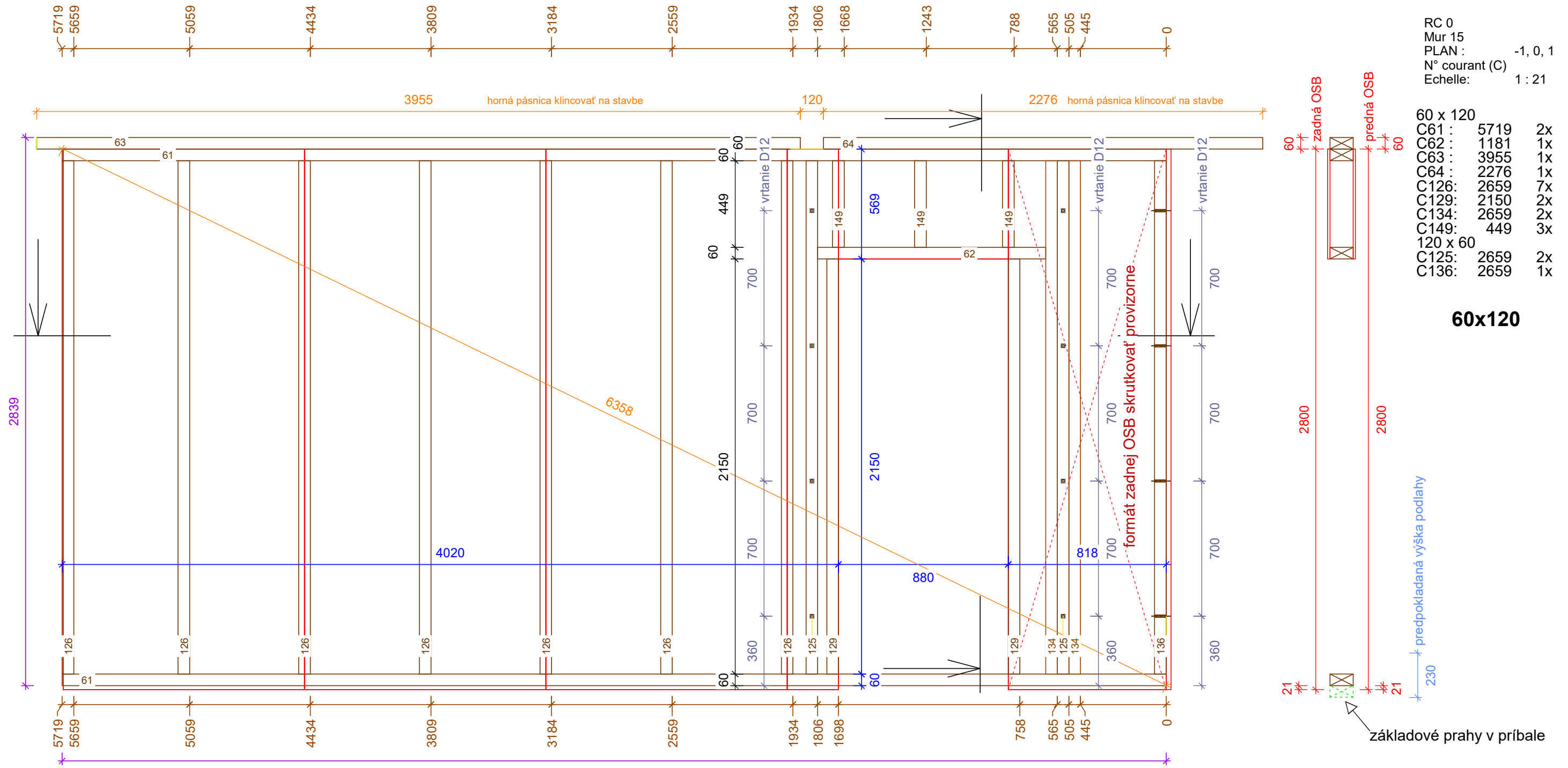

RC 0
Mur 15
PLAN : -1, 0, 1
N° courant (C)
Echelle: 1 : 21

- 60 x 120
- C61 : 5719 2x
- C62 : 1181 1x
- C63 : 3955 1x
- C64 : 2276 1x
- C126: 2659 7x
- C129: 2150 2x
- C134: 2659 2x
- C149: 449 3x
- 120 x 60
- C125: 2659 2x
- C136: 2659 1x

60x120

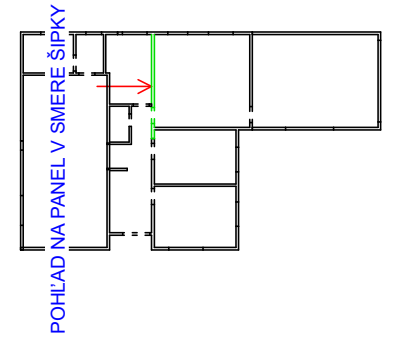
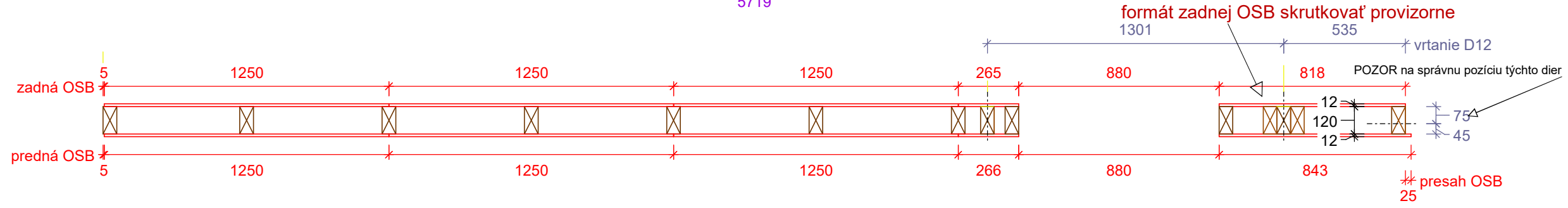

A	04-10-2017		CM
indice	date	modifications	nom

Projet: RD Zábojníkovci	Carnet: 09-115 (plancad n° 115)	Echelle: 1 : 21
Maitre d'ouvrage:	Chargé d'Affaire:	N° d'affaire:
Nom du plan: RC Mur 15		
Dessinateur:		

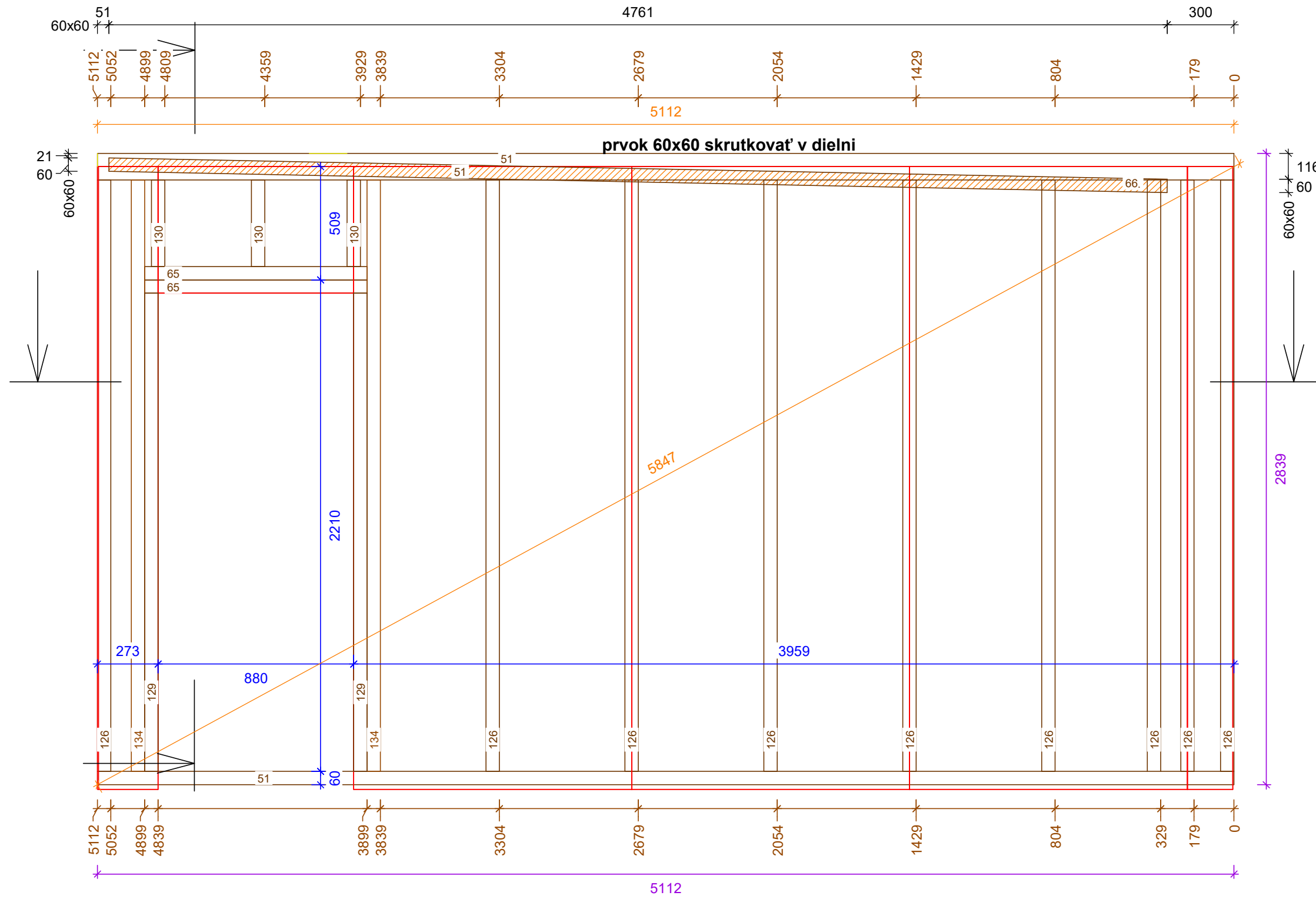

RC 0
 Mur 16
 PLAN : -1, 0, 1
 N° courant (C)
 Echelle: 1 : 20

60 x 60		
C66 :	4762	1x
60 x 120		
C51 :	5112	3x
C65 :	1000	2x
C126 :	2659	9x
C129 :	2150	2x
C130 :	389	3x
C134 :	2659	2x

60x120

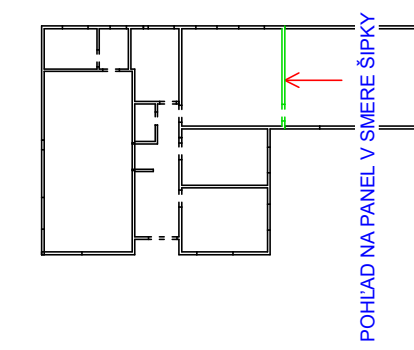
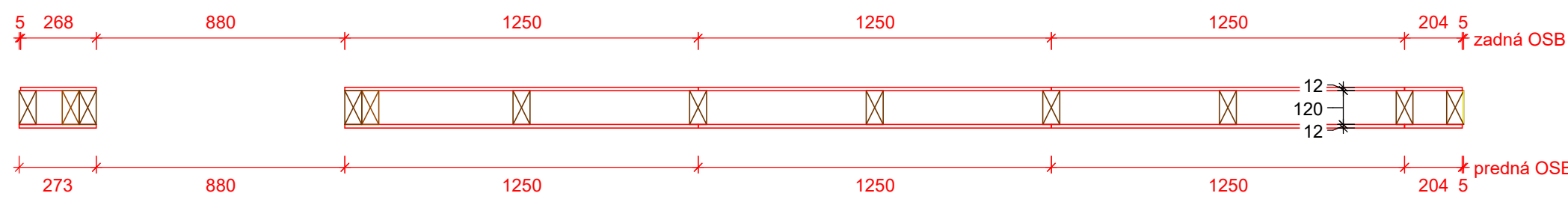
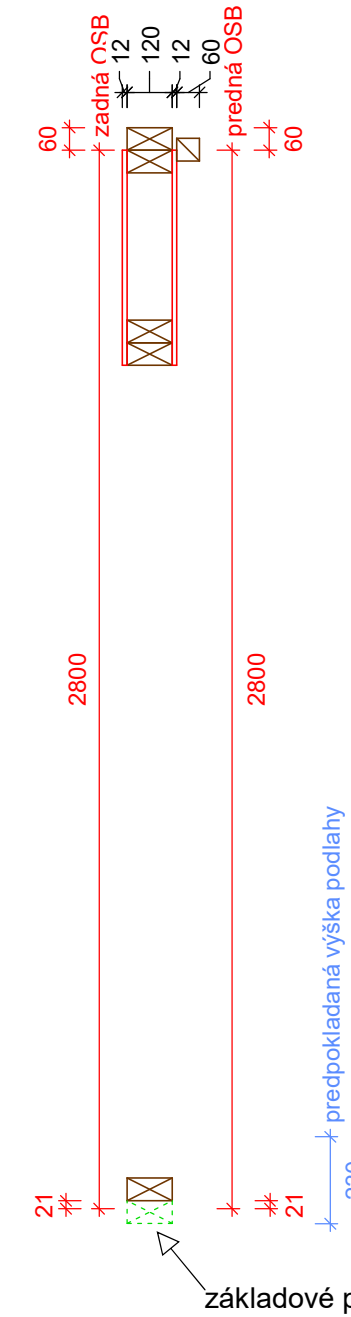

indice	date	modifications	nom
A	04-10-2017		CM

Projet: RD Zábojníkovci	Carnet: 09-116 (placnad n° 116)	Echelle: 1 : 20
Maitre d'ouvrage:	Chargé d'Affaire:	N° d'affaire:
Nom du plan: RC Mur 16		
Dessinateur:		

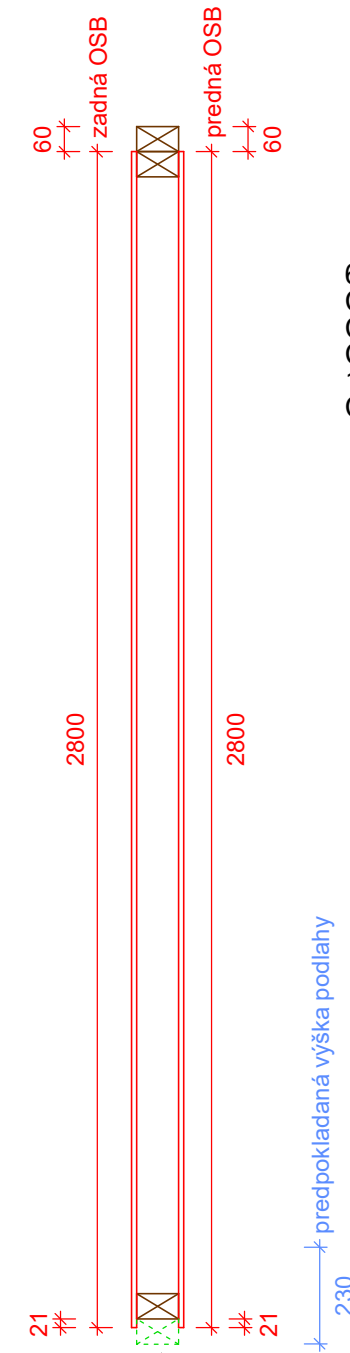
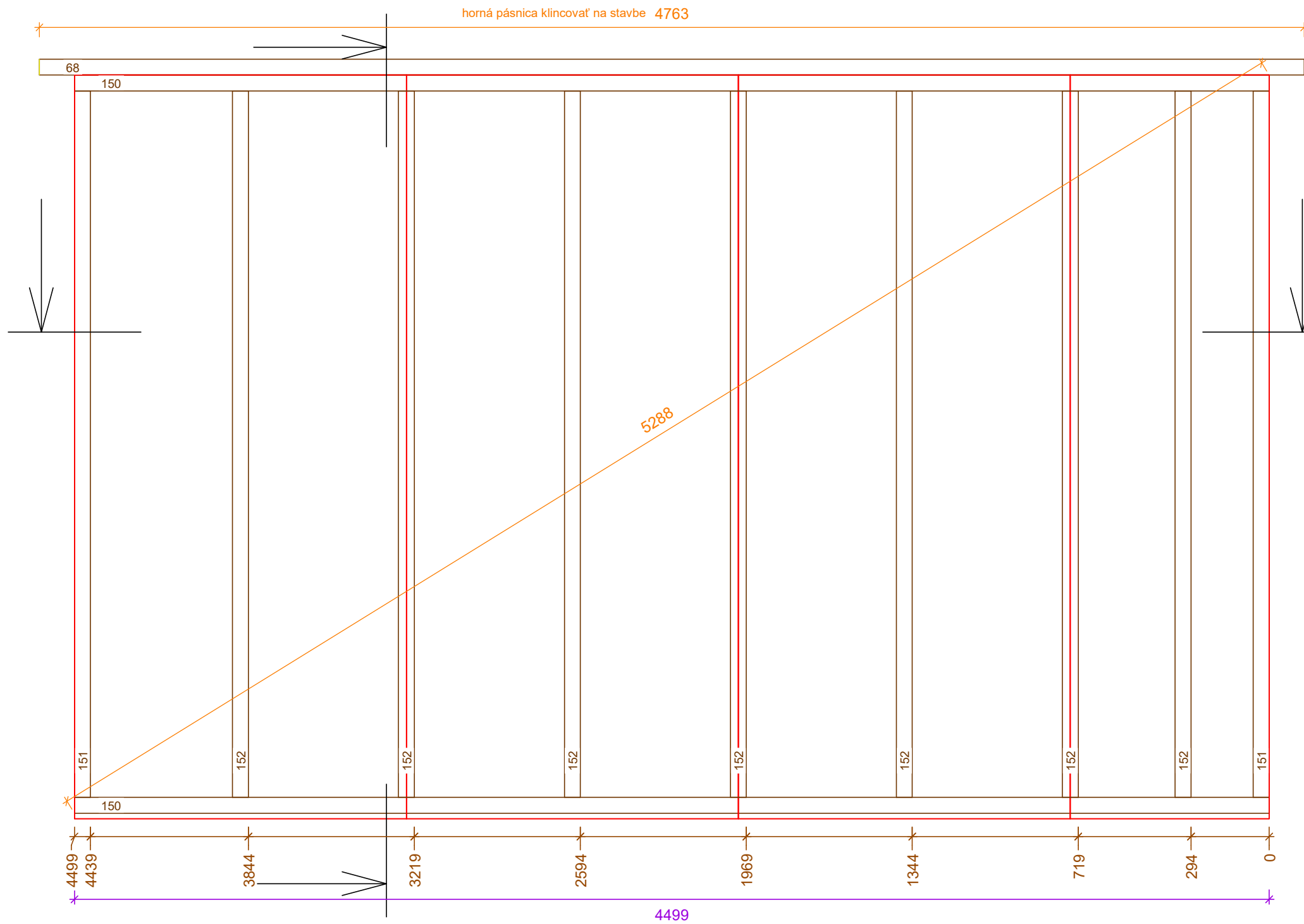

RC 0
Mur 17
PLAN : -1, 0, 1
N° courant (C)
Echelle: 1 : 18

60 x 100
C68 : 4763 1x
C150: 4499 2x
C152: 2659 7x
100 x 60
C151: 2659 2x

60x100

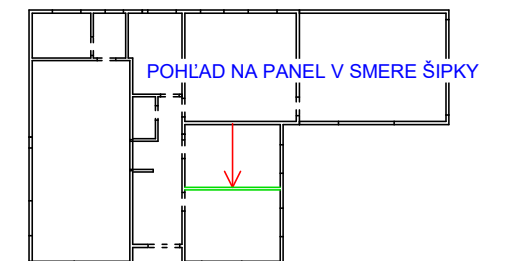
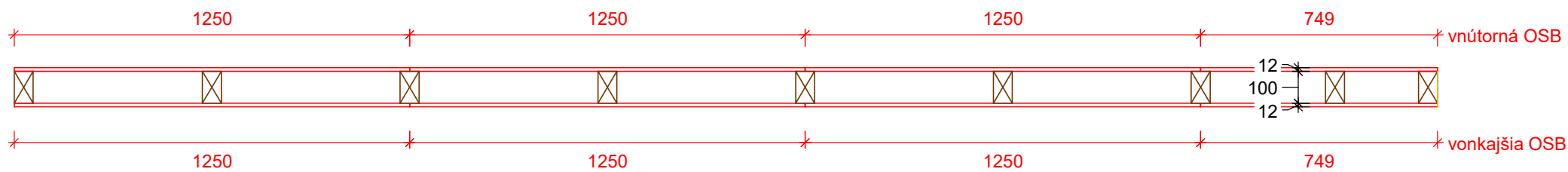

základové prahy v príbele

indice	date	modifications	nom
A	04-10-2017		CM

Projet: RD Zábojníkovci	Carnet: 09-117 (placard n° 117)	Echelle: 1 : 18
Maitre d'ouvrage:	Chargé d'Affaire:	N° d'affaire:
Nom du plan: RC Mur 17		
Dessinateur:		

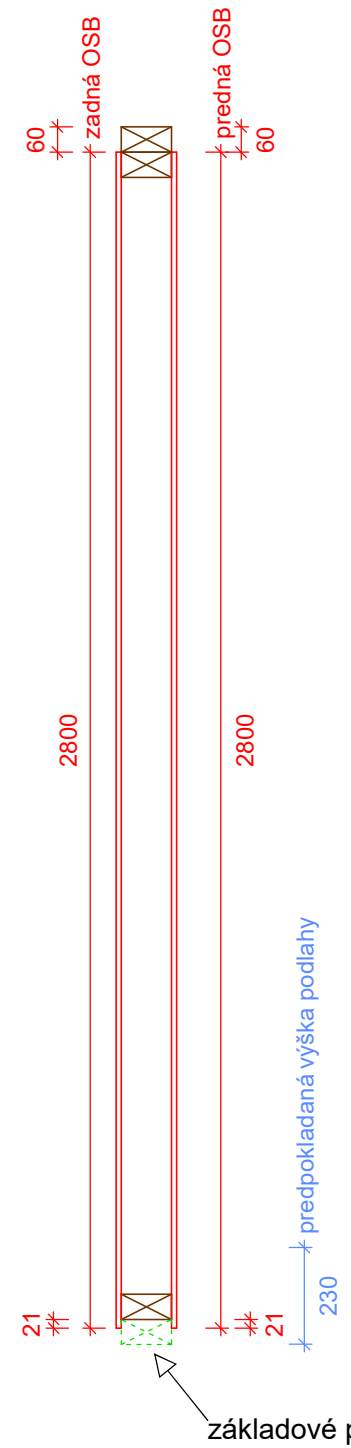
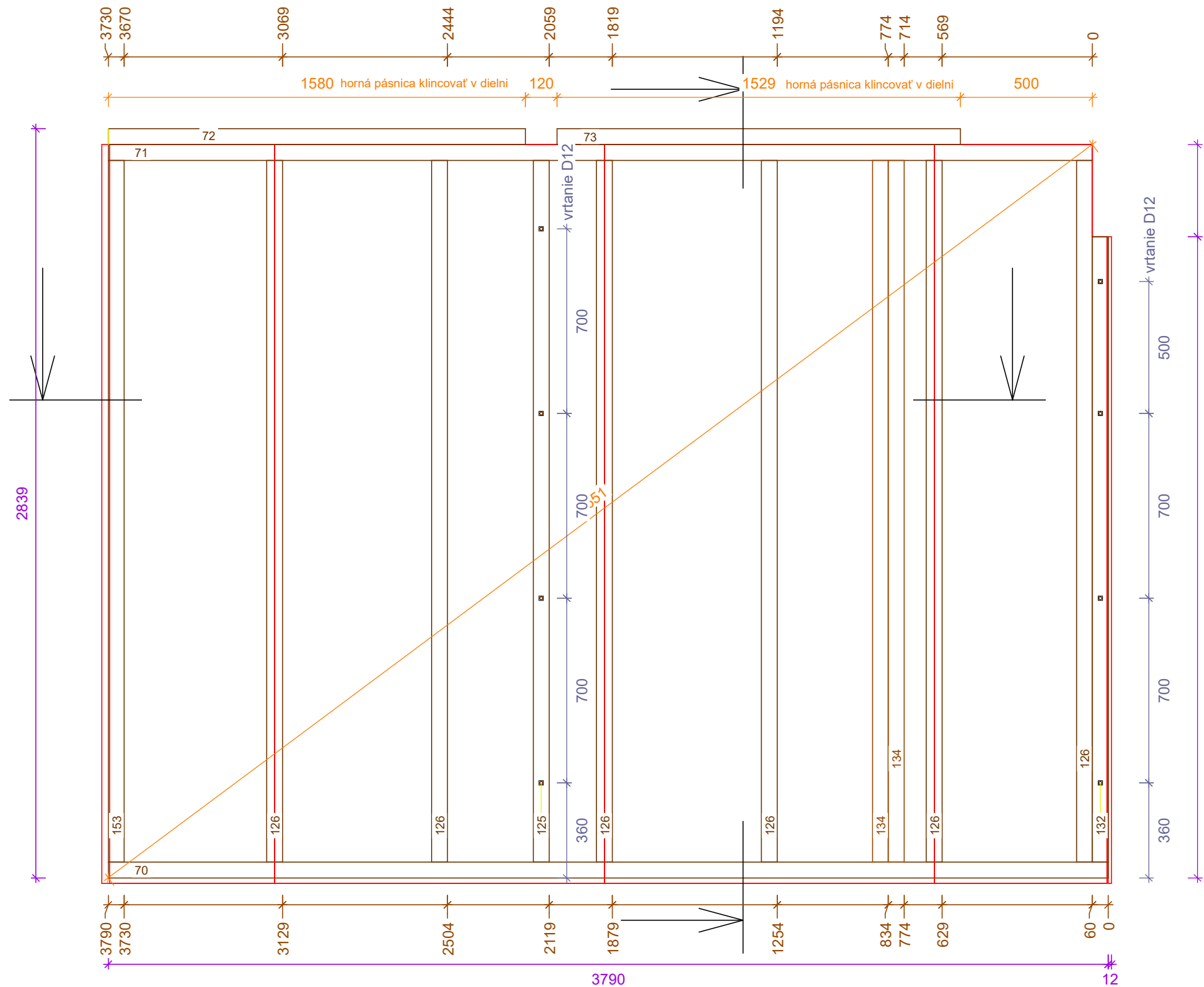

RC 0
Mur 18
PLAN : -1, 0, 1
N° courant (C)
Echelle: 1 : 18

- 60 x 120
- C70 : 3790 1x
- C71 : 3730 1x
- C72 : 1580 1x
- C73 : 1529 1x
- C126: 2659 6x
- C134: 2659 2x
- 120 x 60
- C125: 2659 1x
- C132: 2370 1x
- C153: 2659 1x

60x120

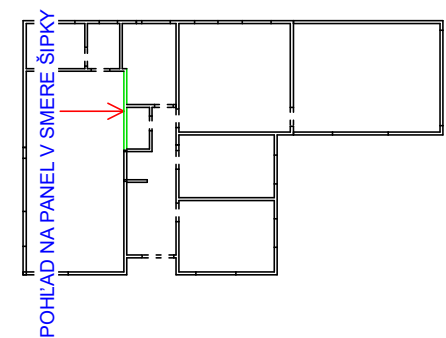
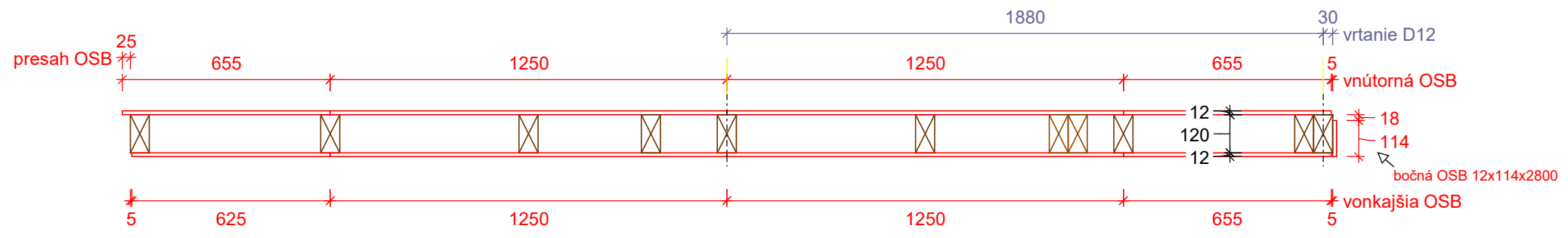

indice	date	modifications	nom
A	04-10-2017		CM

Projet: RD Zábojníkovci	Carnet: 09-118 (plancad n° 118)	Echelle: 1 : 18
Maitre d'ouvrage:	Chargé d'Affaire:	N° d'affaire:
Nom du plan: RC Mur 18		
Dessinateur:		

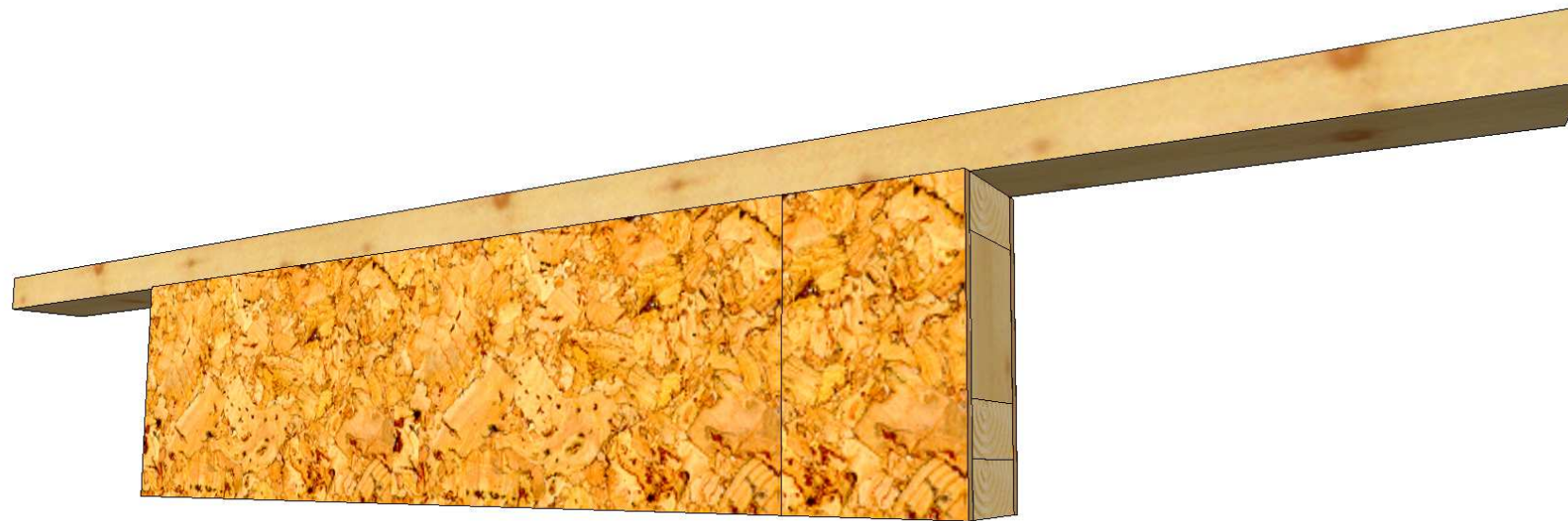

RC 0
 Mur 19
 PLAN : -1, 0, 1
 N° courant (C)
 Echelle: 1 : 10

60 x 120
 C74 : 1459 2x
 C75 : 2469 1x
 C155: 169 2x
 C251: 1459 1x
 120 x 60
 C154: 169 2x

60x120

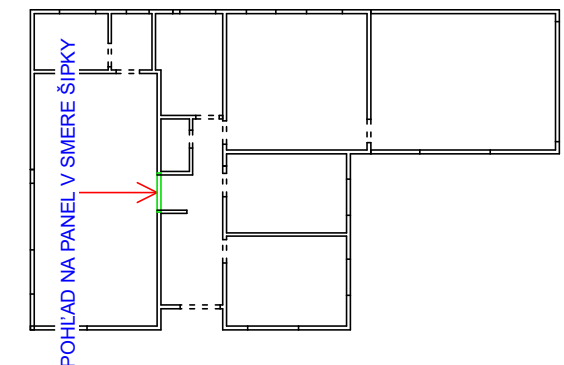
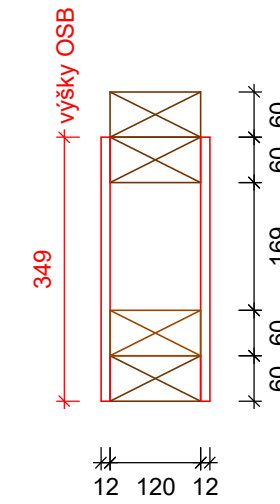
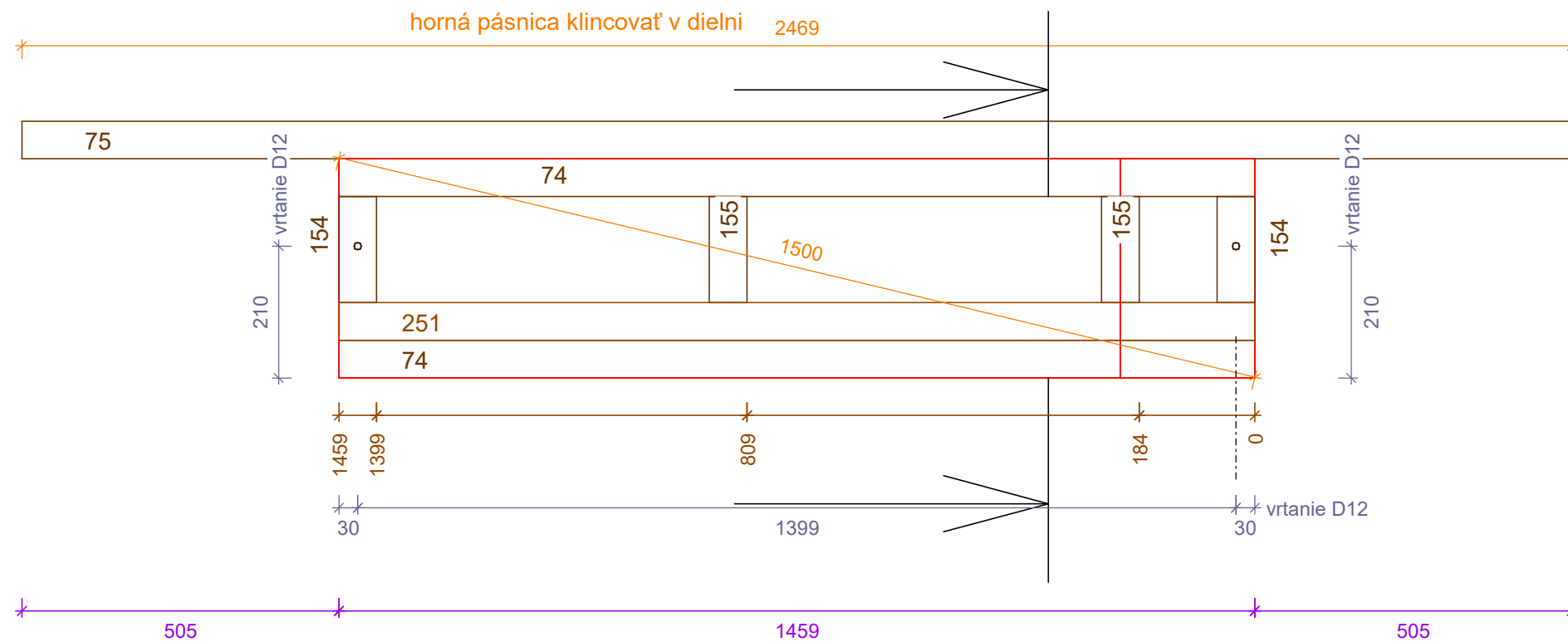

indice	date	modifications	nom
A	04-10-2017		CM

Projet: RD Zábojníkovci	Carnet: 09-119 (plancad n° 119)	Echelle: 1 : 10
Maitre d'ouvrage:	Chargé d'Affaire:	N° d'affaire:
Nom du plan: RC Mur 19		
Dessinateur:		

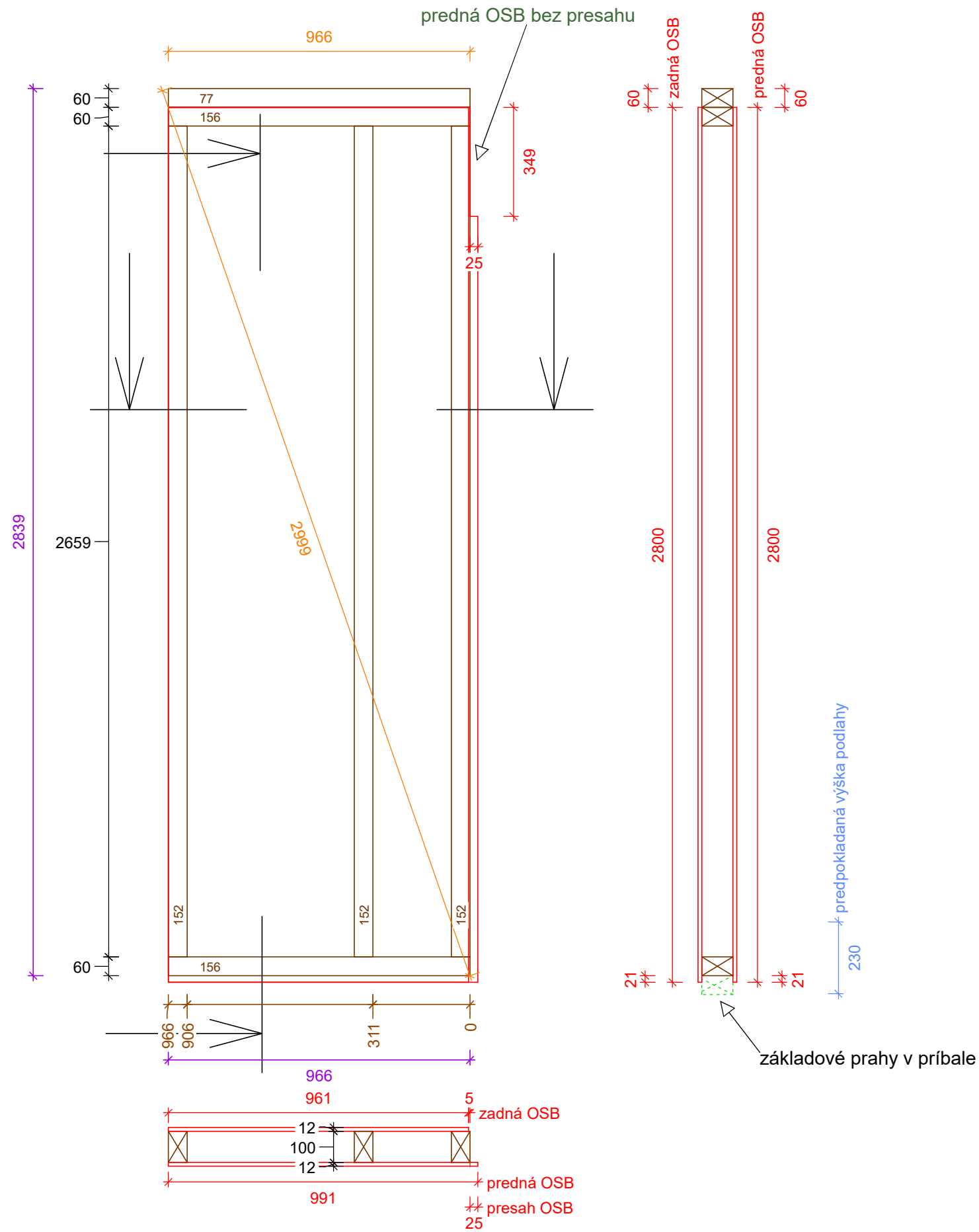

RC 0
 Mur 20
 PLAN : -1, 0, 1
 N° courant (C)
 Echelle: 1 : 16

60 x 100
 C77 : 966 1x
 C152: 2659 3x
 C156: 966 2x

60x100

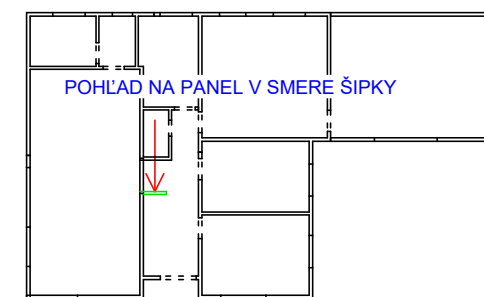

A	04-10-2017		CM
indice	date	modifications	nom

Projet: RD Zábojníkovci	Carnet: 09-120 (plancad n° 120)	Echelle: 1 : 16
Maitre d'ouvrage:	Chargé d'Affaire:	N° d'affaire:
Nom du plan: RC Mur 20		
Dessinateur:		

RC 0
 Mur 21
 PLAN : -1, 0, 1
 N° courant (C)
 Echelle: 1 : 17

60 x 100
 C79 : 1066 1x
 C152: 2659 3x
 C157: 1066 2x

60x100

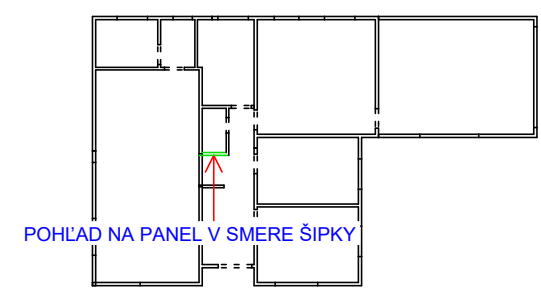
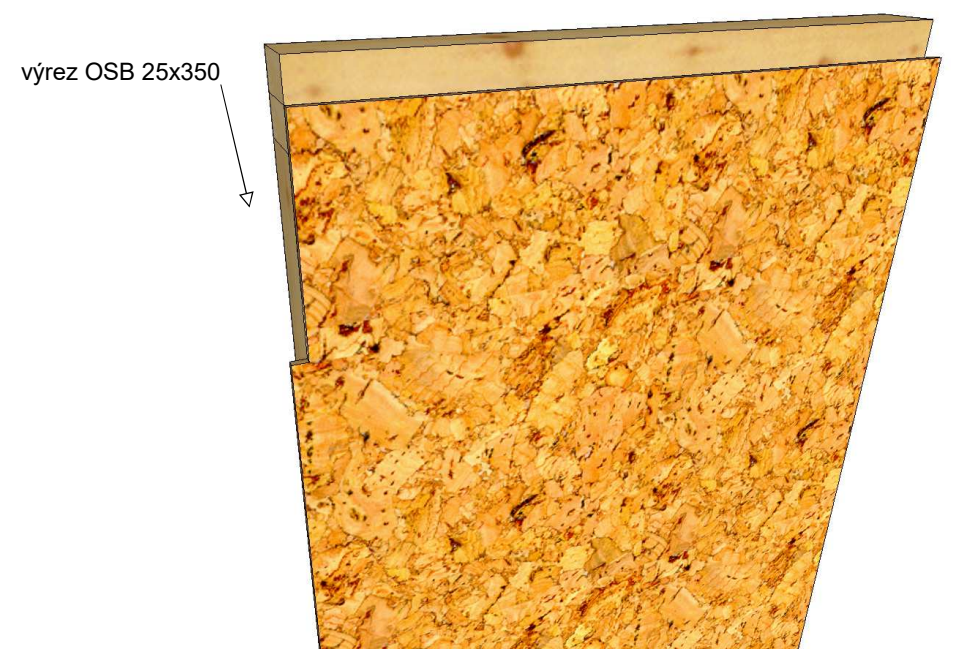
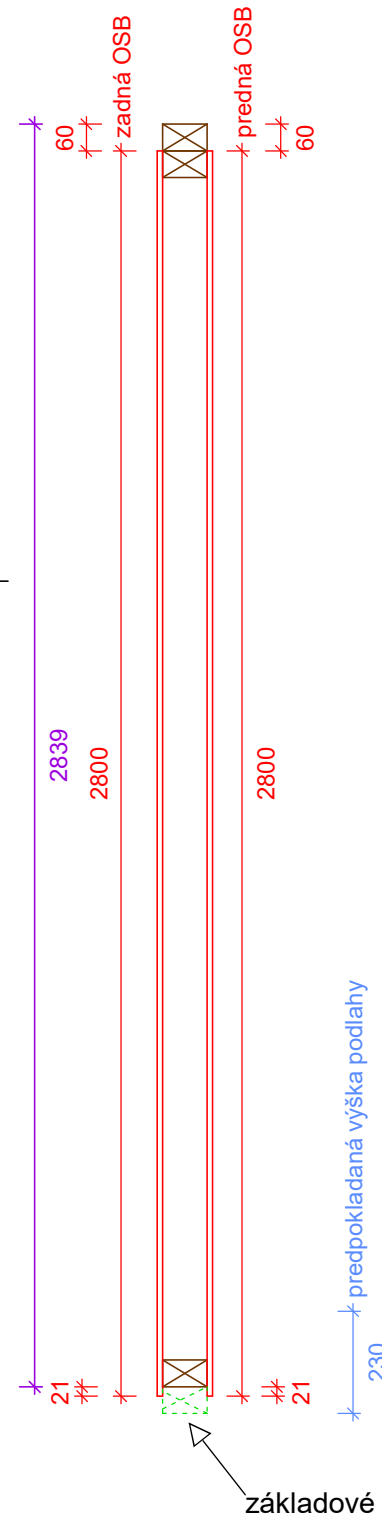
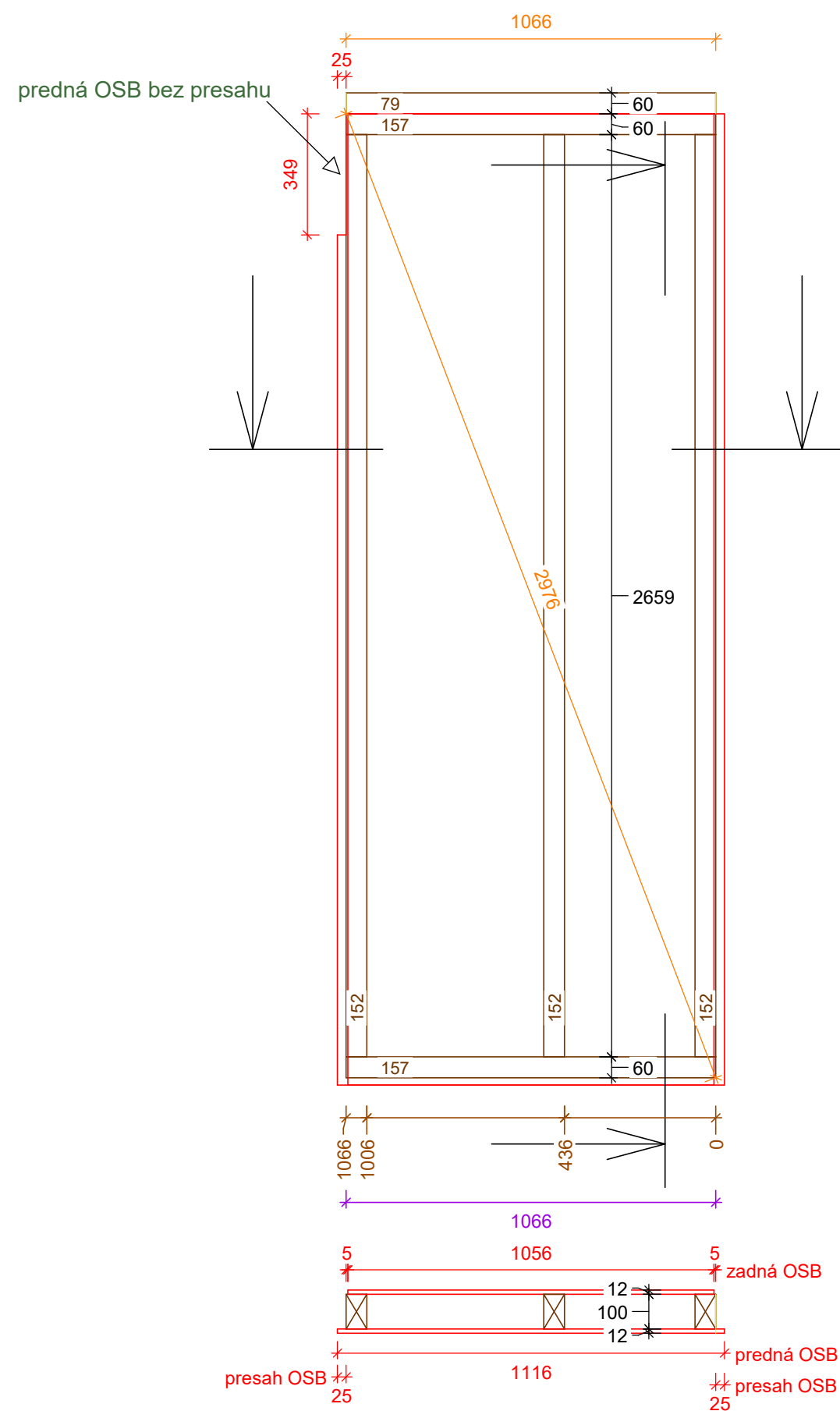

A	04-10-2017		CM
indice	date	modifications	nom

Projet: RD Zábojníkovci	Carnet: 09-121 (placád n° 121)	Echelle: 1 : 17
Maitre d'ouvrage:	Chargé d'Affaire:	N° d'affaire:
Nom du plan: RC Mur 21		
Dessinateur:		

RC 0
 Mur 22
 PLAN : -1, 0, 1
 N° courant (C)
 Echelle: 1 : 18

60 x 100
 C81 : 680 1x
 C82 : 2087 1x
 C152: 2659 3x
 C158: 2087 2x
 C160: 2659 3x
 C161: 449 2x
 100 x 60
 C151: 2659 1x
 C159: 2659 1x

60x100

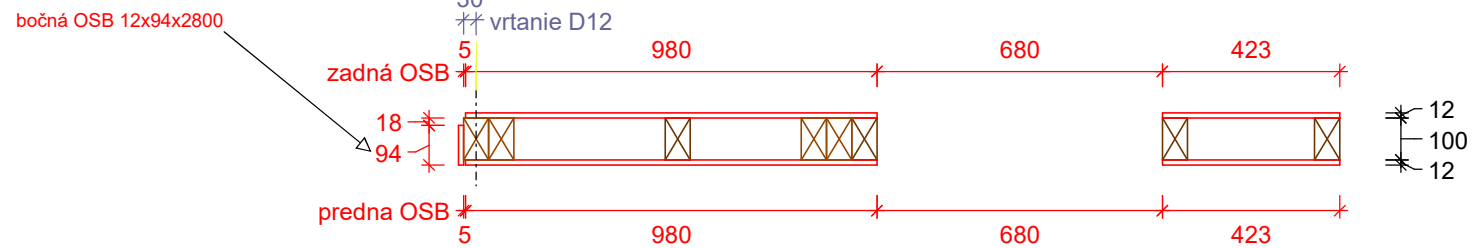
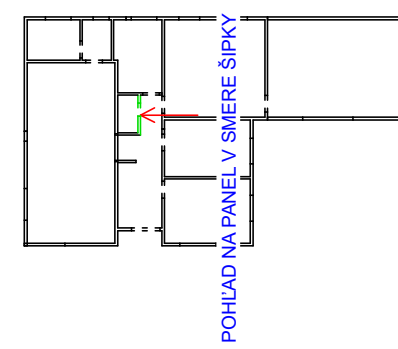
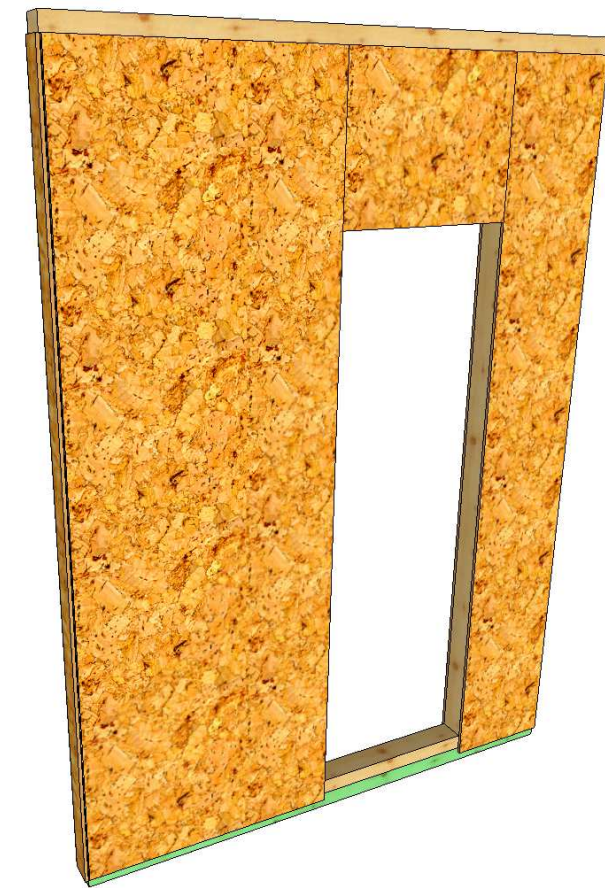
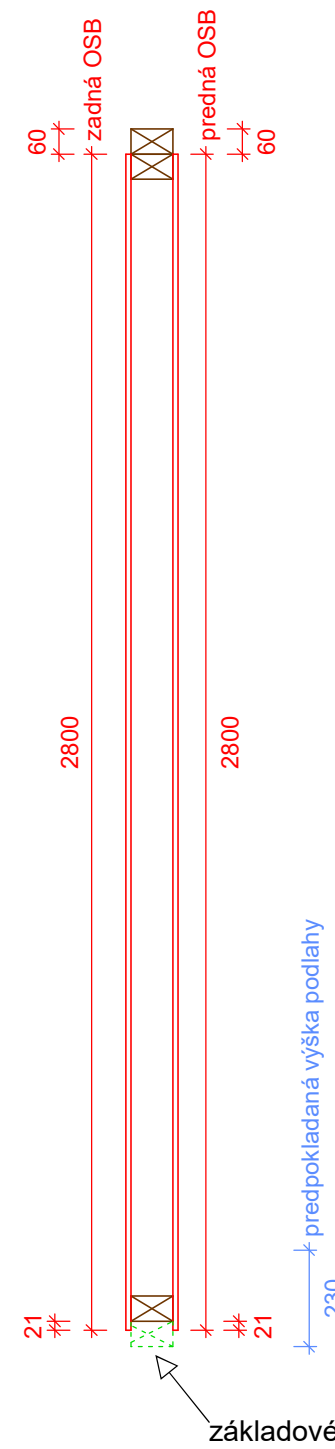
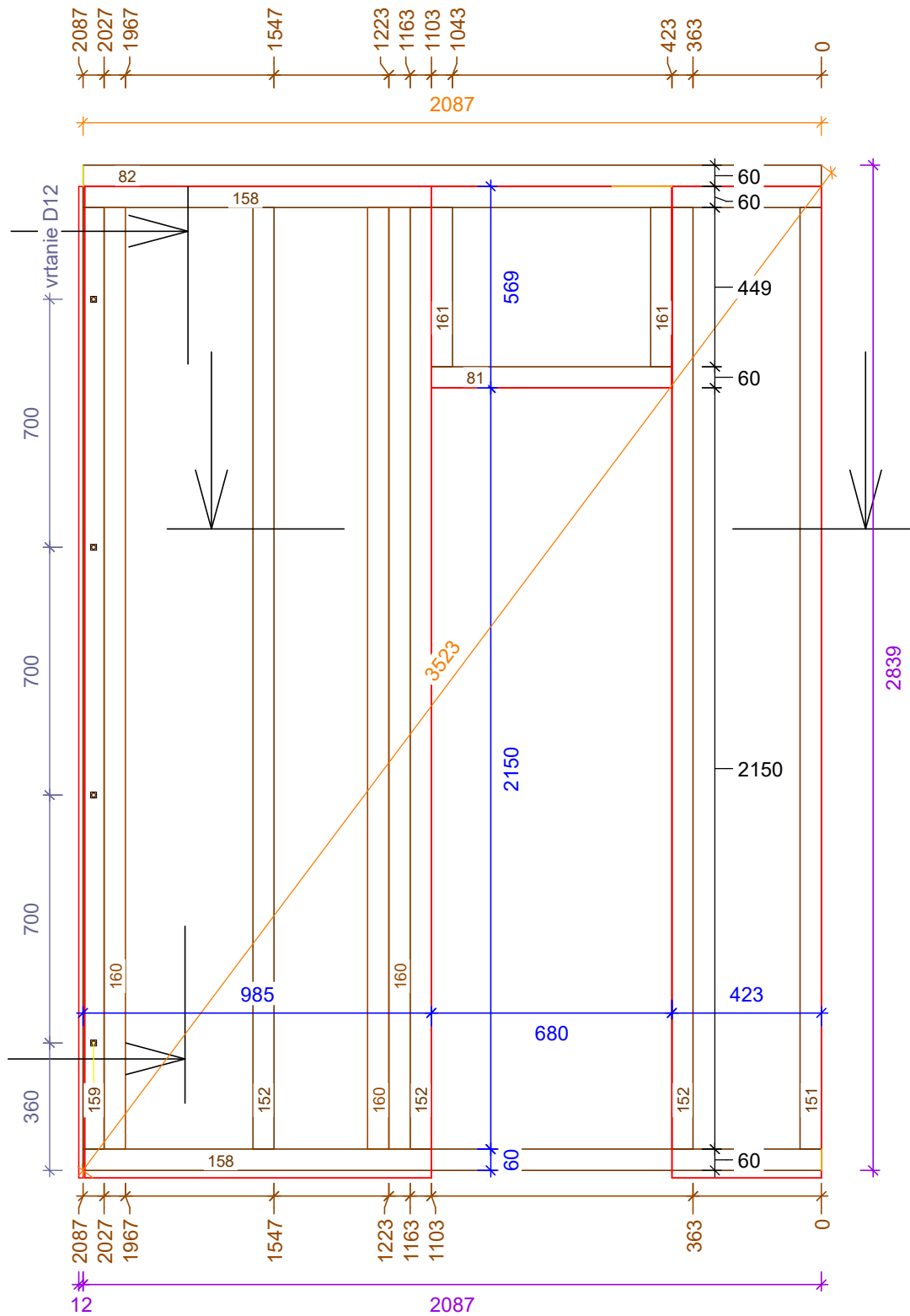

indice	date	modifications	nom
A	04-10-2017		CM

Projet: RD Zábojníkovci	Carnet: 09-122 (plancad n° 122)	Echelle: 1 : 18
Maitre d'ouvrage:	Chargé d'Affaire:	N° d'affaire:
Nom du plan: RC Mur 22		
Dessinateur:		

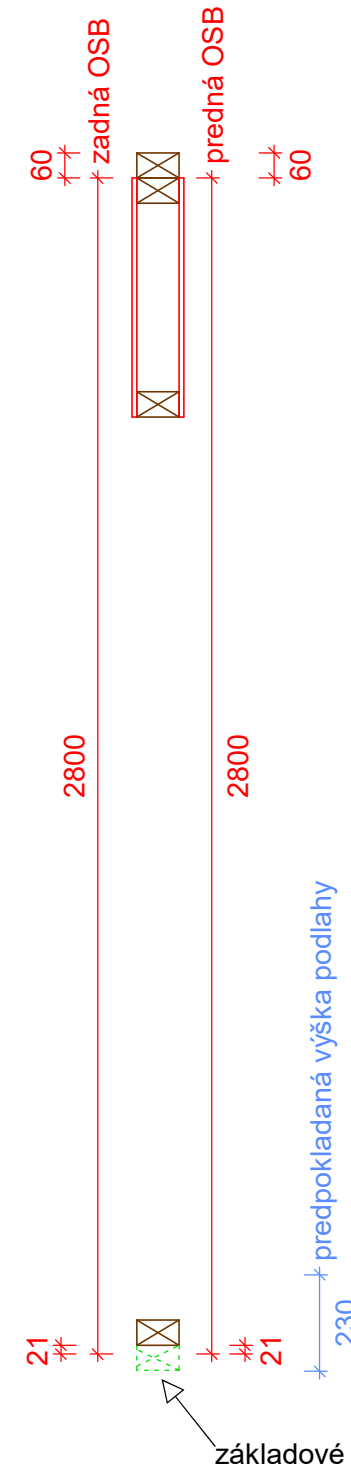
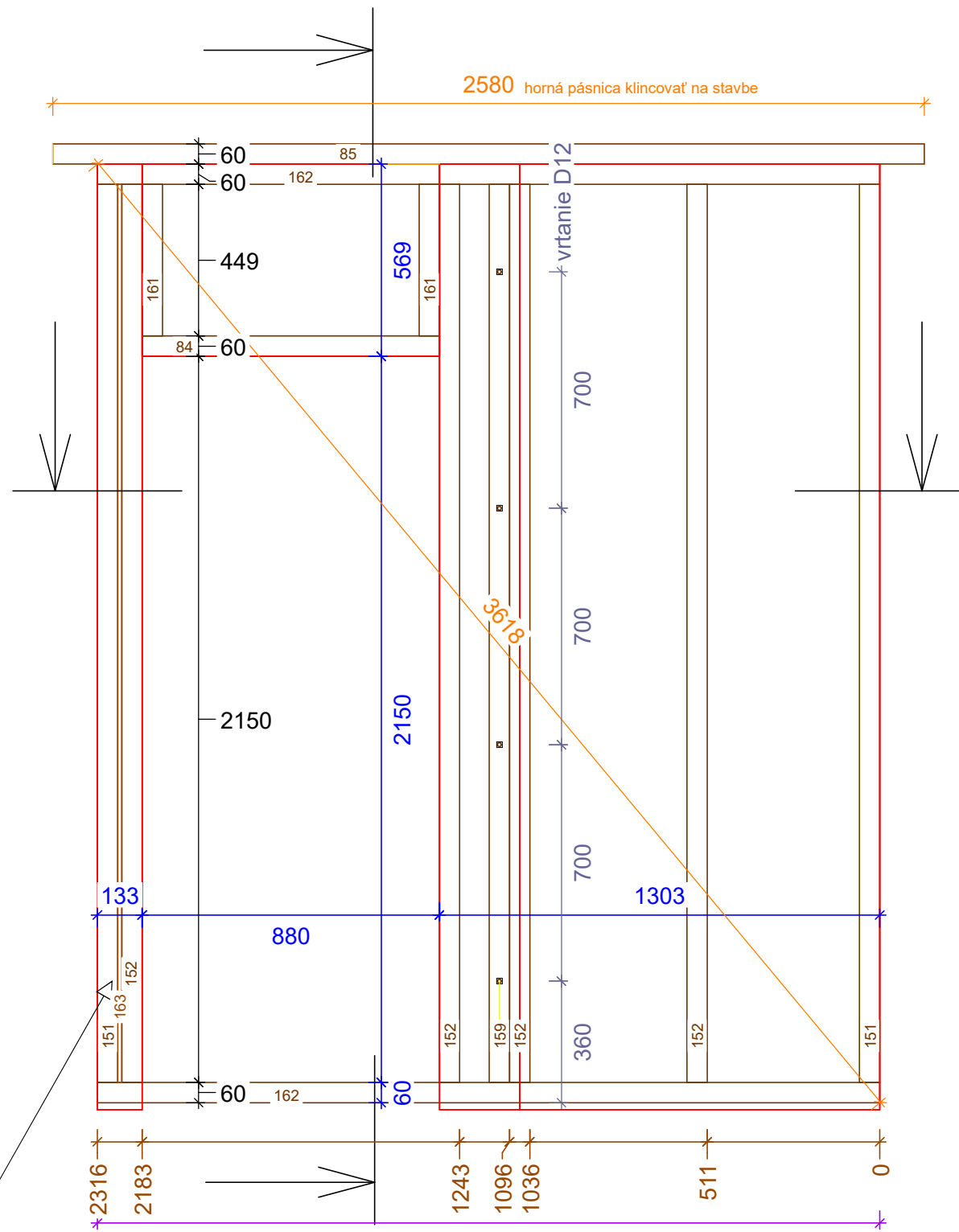

RC 0
Mur 23
PLAN : -1, 0, 1
N° courant (C)
Echelle: 1 : 18

- 12 x 100
- C163: 2659 1x
- 60 x 100
- C84 : 880 1x
- C85 : 2580 1x
- C152: 2659 4x
- C161: 449 2x
- C162: 2316 2x
- 100 x 60
- C151: 2659 2x
- C159: 2659 1x

60x100

možno použiť pás OSB 12

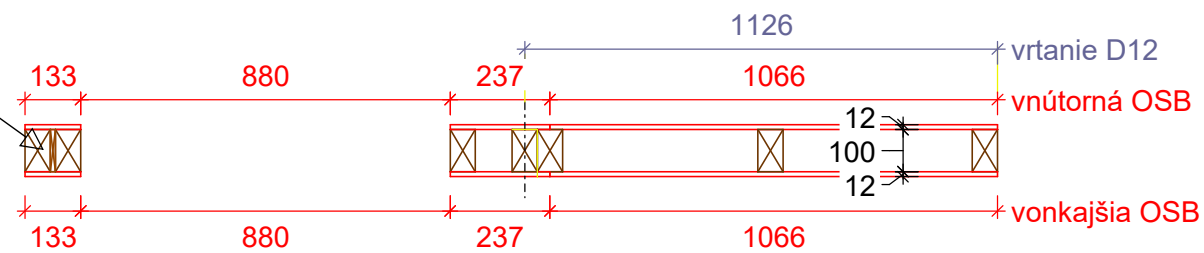

POHLAD NA PANEL V SMERE ŠÍPKY

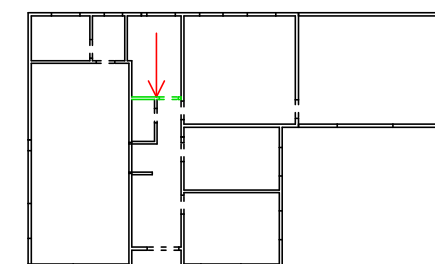

základové prahy v príbale

indice	date	modifications	nom
A	04-10-2017		CM

Projet: RD Zábojníkovci	Carnet: 09-123 (placnad n° 123)	Echelle: 1 : 18
Maitre d'ouvrage:	Chargé d'Affaire:	N° d'affaire:
Nom du plan: RC Mur 23		
Dessinateur:		

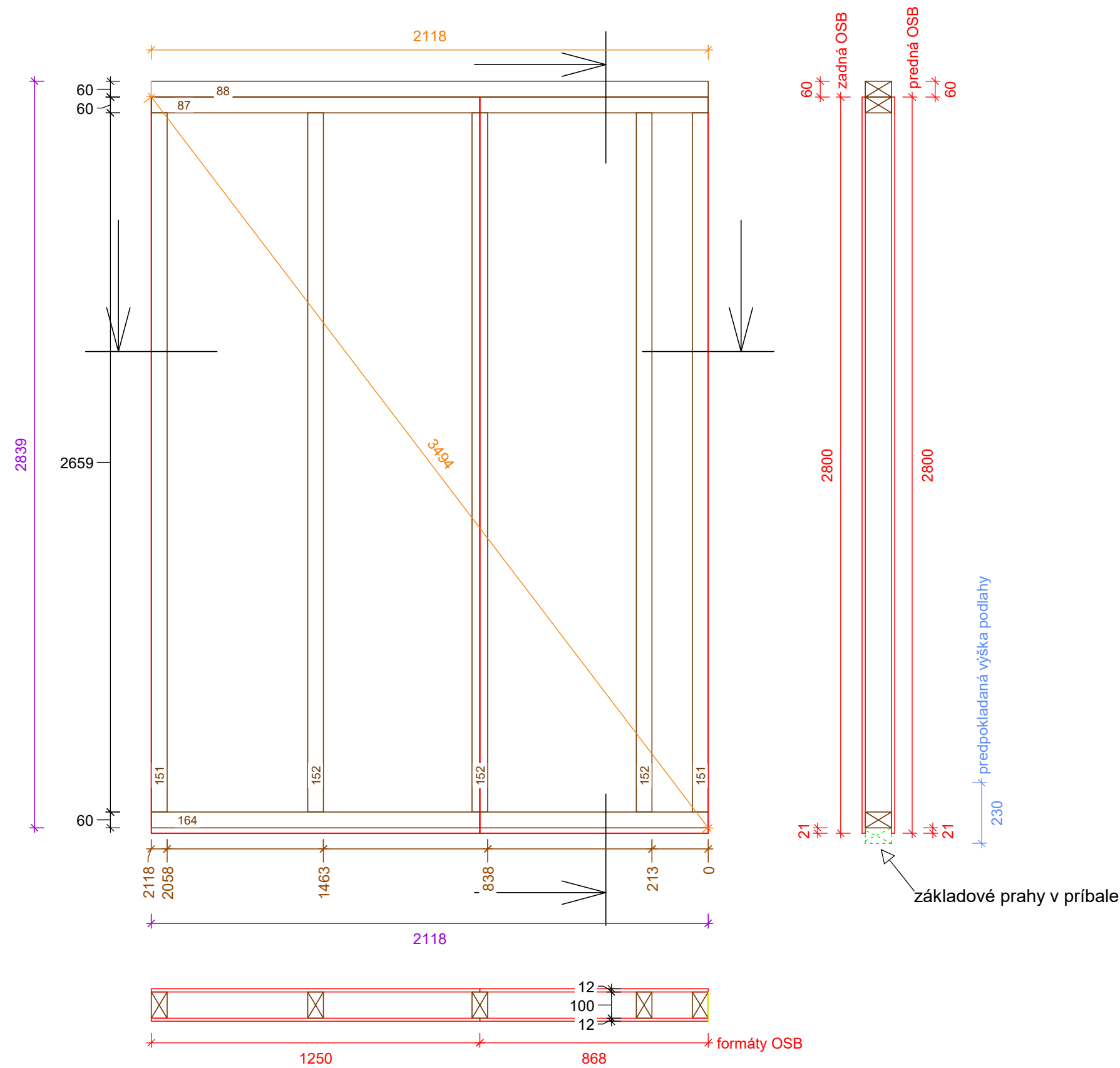

RC 0
 Mur 24
 PLAN : -1, 0, 1
 N° courant (C)
 Echelle: 1 : 18

60 x 100
 C87 : 2118 1x
 C88 : 2118 1x
 C152: 2659 3x
 C164: 2118 1x
 100 x 60
 C151: 2659 2x

60x100

POHLAD NA PANEL V SMERE ŠÍPKY

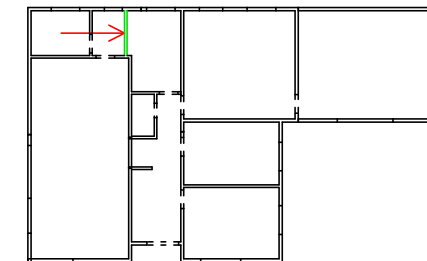

A	04-10-2017		CM
indice	date	modifications	nom

Projet: RD Zábojníkovci	Carnet: 09-124 (placád n° 124)	Echelle: 1 : 18
Maitre d'ouvrage:	Chargé d'Affaire:	N° d'affaire:
Nom du plan: RC Mur 24		
Dessinateur:		

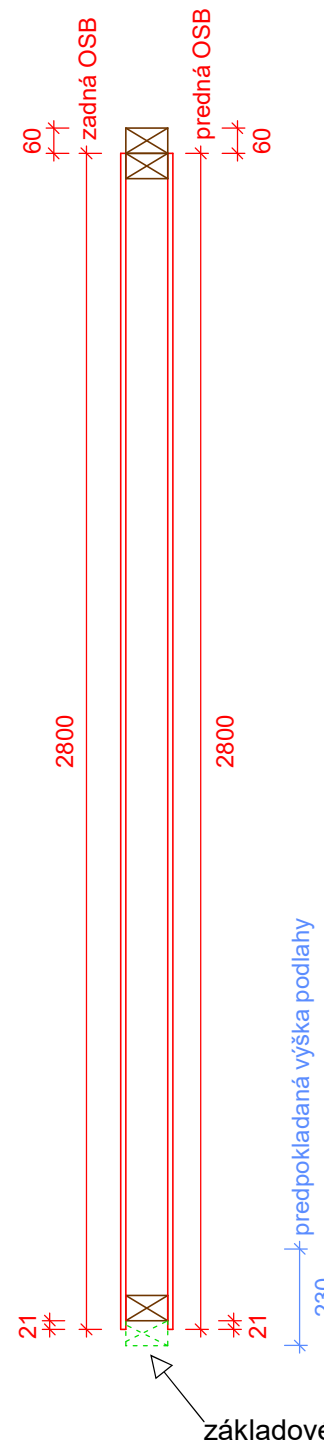
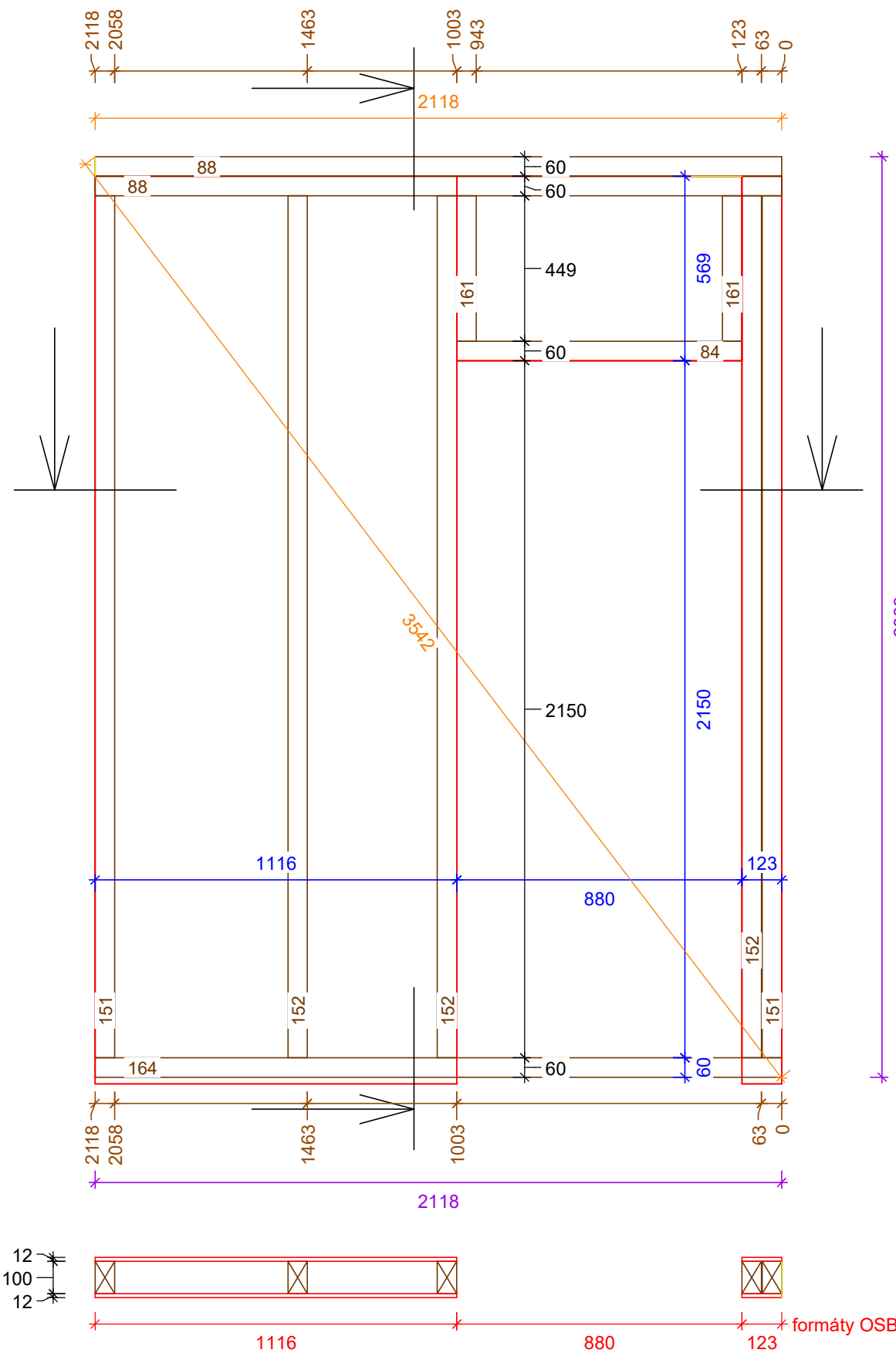

RC 0
Mur 25
PLAN : -1, 0, 1
N° courant (C)
Echelle: 1 : 18

60 x 100
C84 : 880 1x
C88 : 2118 2x
C152: 2659 3x
C161: 449 2x
C164: 2118 1x
100 x 60
C151: 2659 2x

60x100

POHLAD NA PANEL V SMERE ŠÍPKY

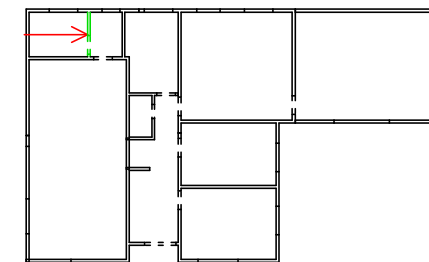

A	04-10-2017		CM
indice	date	modifications	nom

Projet: RD Zábojníkovci	Carnet: 09-125 (plancad n° 125)	Echelle: 1 : 18
Maitre d'ouvrage:	Chargé d'Affaire:	N° d'affaire:
Nom du plan: RC Mur 25		
Dessinateur:		

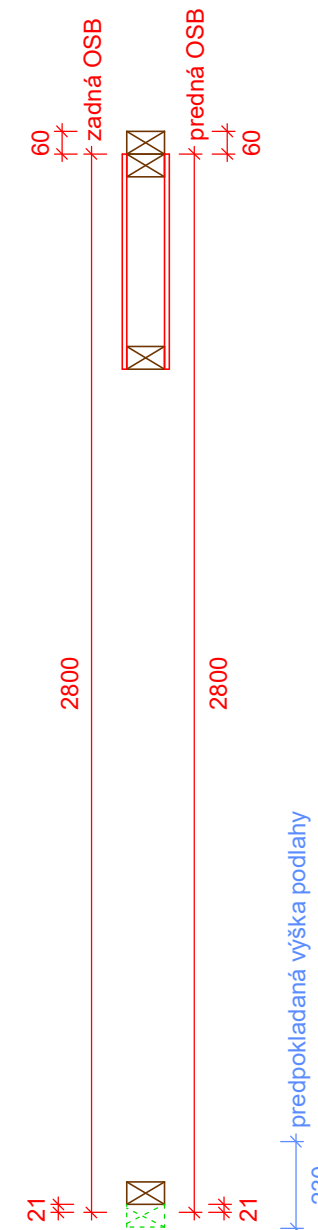
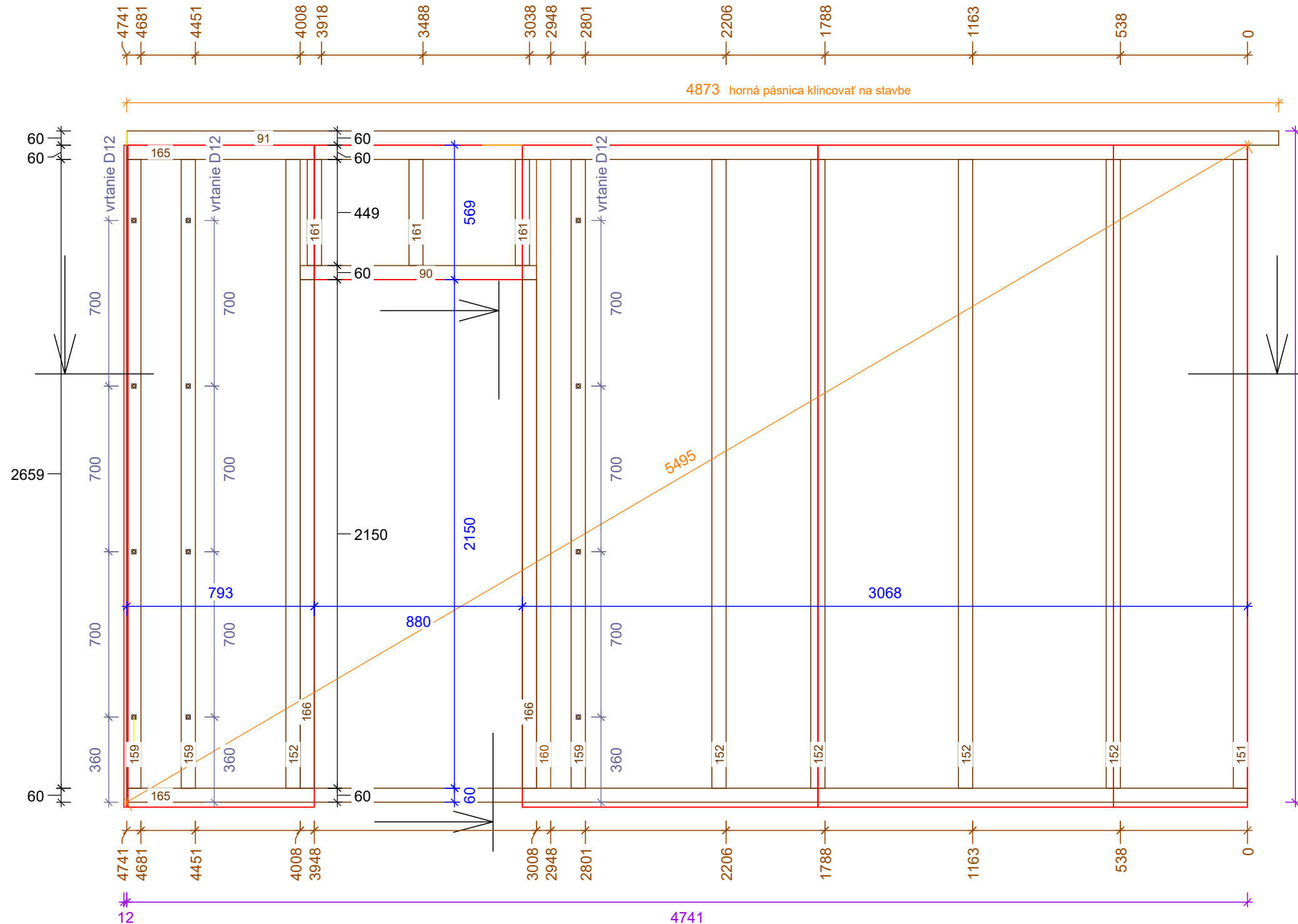

RC 0
 Mur 26
 PLAN : -1, 0, 1
 N° courant (C)
 Echelle: 1 : 20

60 x 100		
C90 :	1000	1x
C91 :	4873	1x
C152:	2659	5x
C160:	2659	1x
C161:	449	3x
C165:	4741	2x
C166:	2150	2x
100 x 60		
C151:	2659	1x
C159:	2659	3x

60x100

základové prahy v príbale

POHLAD NA PANEL V SMERE ŠÍPKY

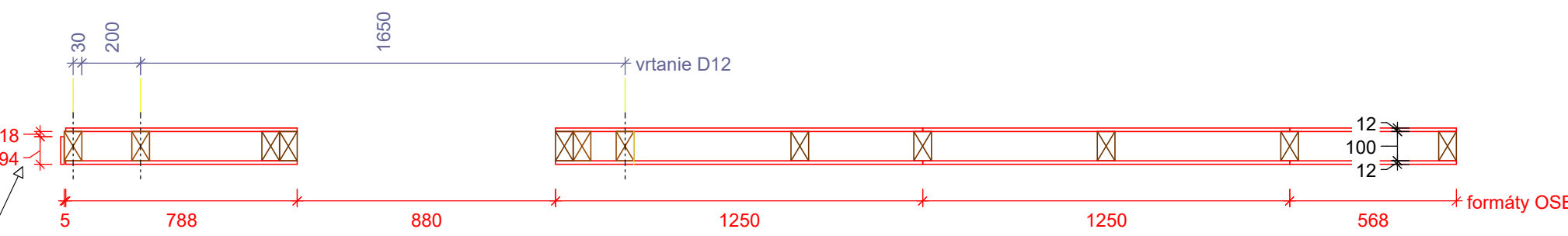
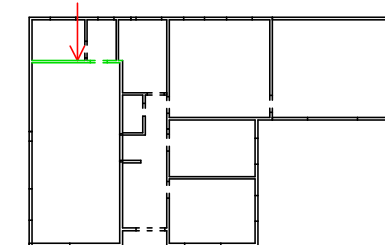

bočná OSB 12x94x2800

indice	date	modifications	nom
A	04-10-2017		CM

Projet: RD Zábojníkovci	Carnet: 09-126 (placnad n° 126)	Echelle: 1 : 20
Maitre d'ouvrage:	Chargé d'Affaire:	N° d'affaire:
Nom du plan: RC Mur 26		
Dessinateur:		

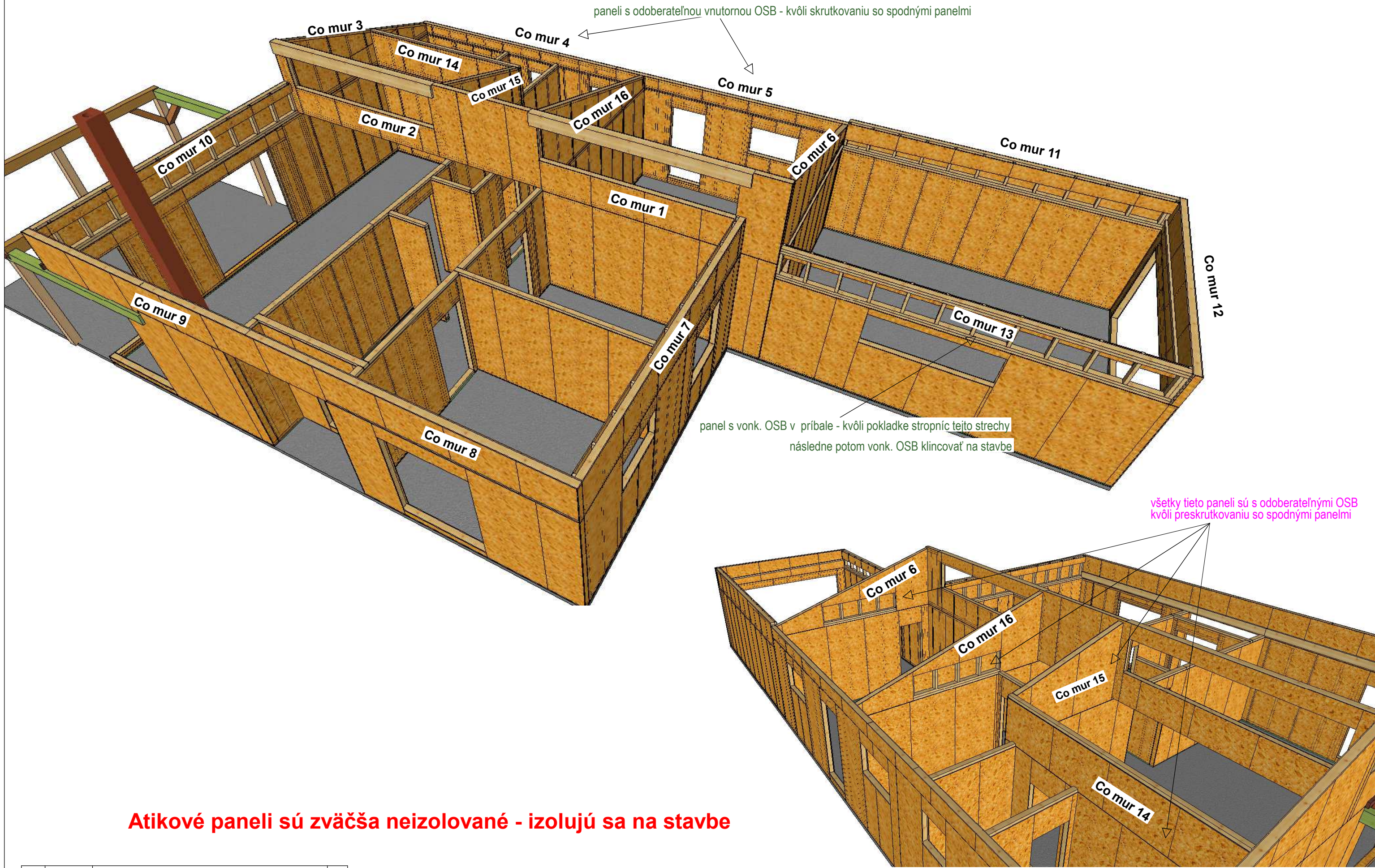

Atikové paneli sú zväčša neizolované - izolujú sa na stavbe

A	10-10-2017		CM
indice	date	modifications	nom

Projet: RD Zábojníkovci	Carnet: 09-130 (plancad n° 130)	Echelle: 1/10°
Maitre d'ouvrage:	Chargé d'Affaire:	N° d'affaire:
Nom du plan: rozloženie+montáž poschodia		
Dessinateur:		

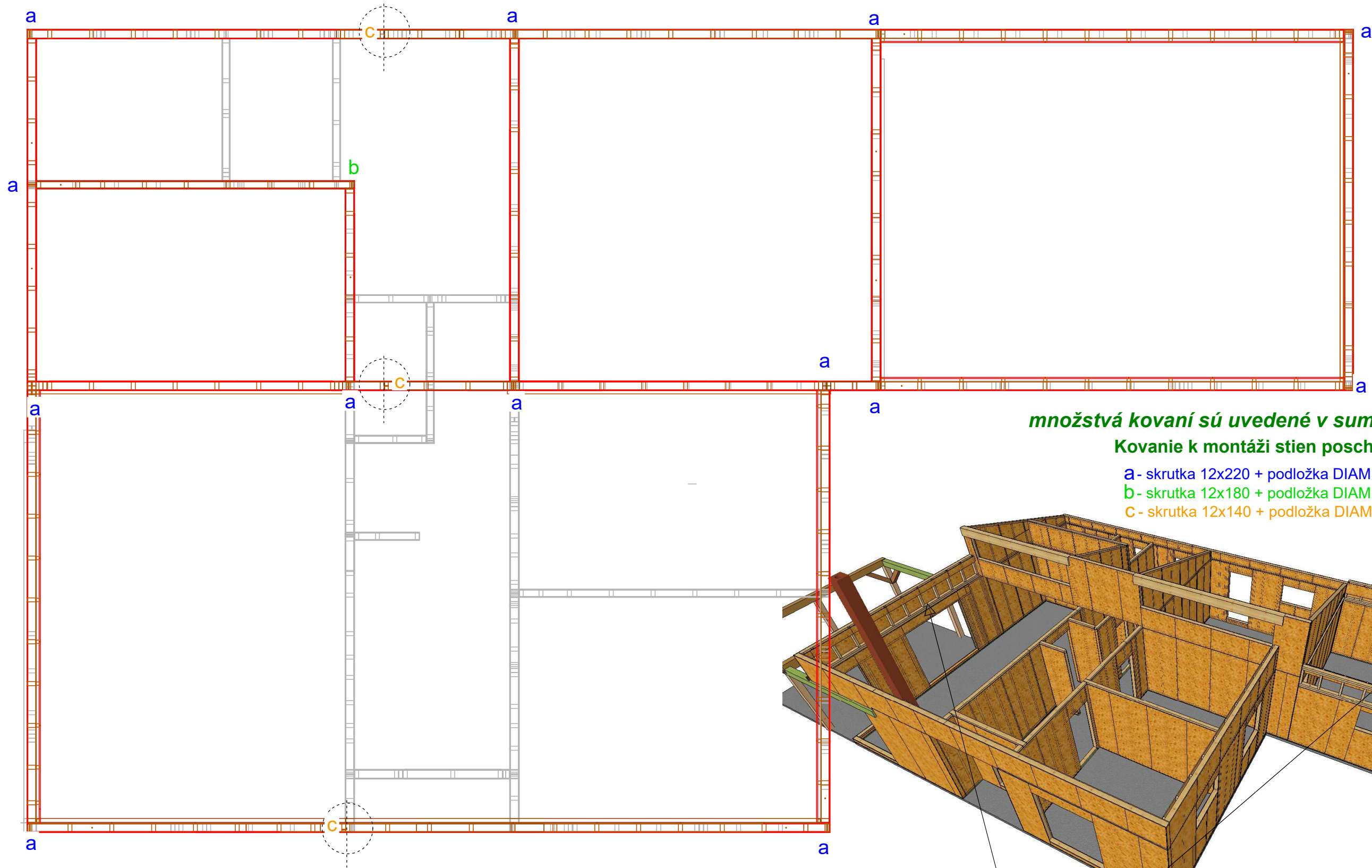

množstvá kovaní sú uvedené v sumárnej tabuľke (excel)

Kovanie k montáži stien poschodia :

a - skrutka 12x220 + podložka DIAM 13

b - skrutka 12x180 + podložka DIAM 13

c - skrutka 12x140 + podložka DIAM 13

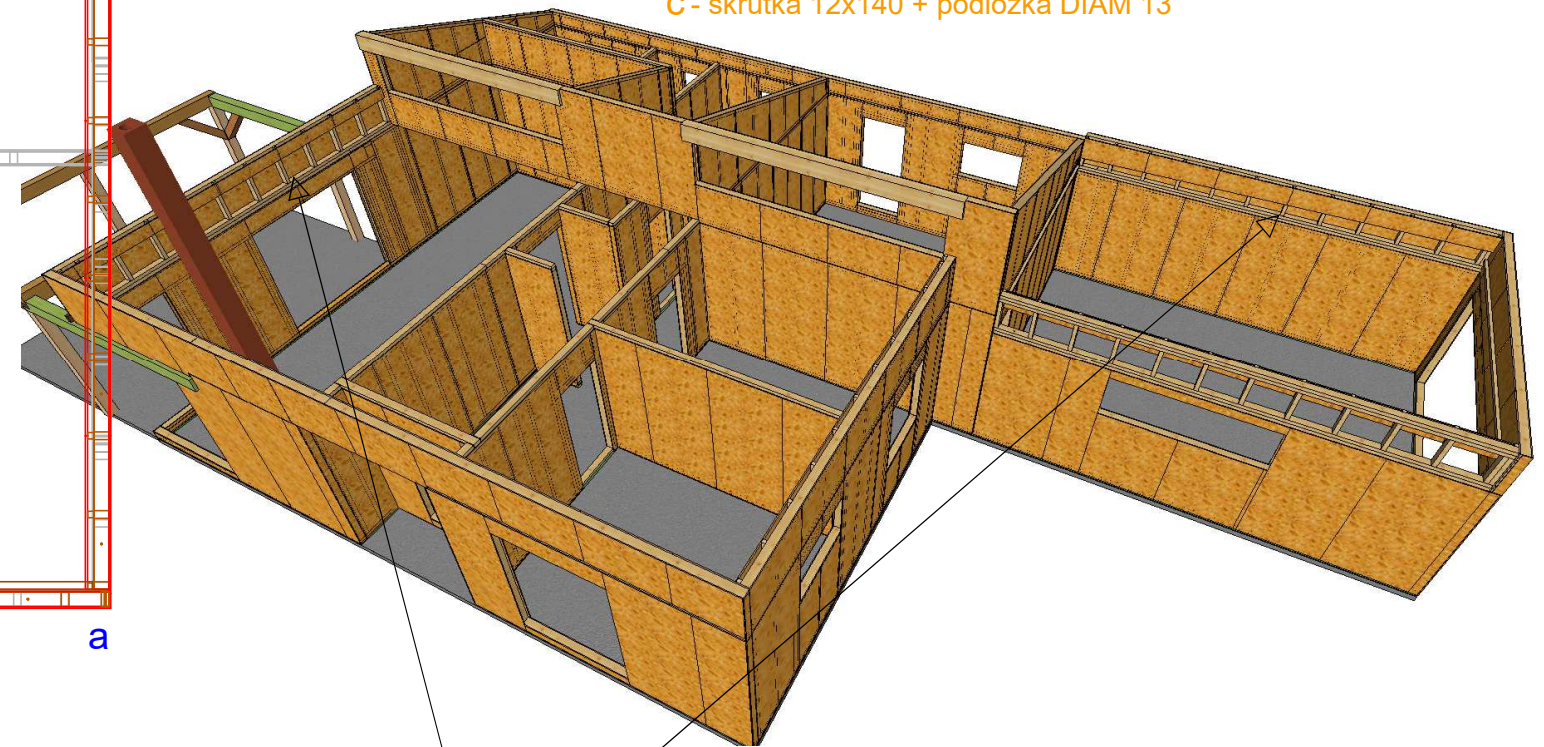

všetky spoje spodného a horného panela skrutkovať
skrutkami typ C - podľa predvŕtaných dier

Montážne kovanie a spoj. prvky k poschodiu = pozri tiež plán č.130

A	13-10-2017		CM
indice	date	modifications	nom

Projet: RD Zábojníkovci	Carnet: 135 (placard n° 135)	Echelle: 1/10°
Maitre d'ouvrage:	Chargé d'Affaire:	N° d'affaire:
Nom du plan: montážne kovanie poschodia		
Dessinateur:		

PO 0
 Stěna 1
 Rovina : -1, 0, 1, 3, 6
 Pořadové číslo
 Měřítko: 1 : 28

L93	1x	KVH, 180 x 300	4830
L171	1x	Rám	548
L172	1x	KVH, 120 x 60	840
L175	2x	Stojky	1508
L178	1x	Stojky	1688
		KVH, 60 x 120	
L45	1x	Rám	7410
L92	1x	Rám	4650
L94	1x	Rám	1840
L95	1x	Rám	2462
L96	1x	Rám	740
L137	1x	Stojky	840
L167	1x	Stojky	1628
L168	2x	Stojky	1628
L169	1x	Stojky	1628
L170	1x	Stojky	1448
L173	1x	Stojky	548
L174	8x	Stojky	608
L176	1x	Stojky	1688
L177	1x	Stojky	1688
L252	1x	Entretoise	2020
L253	1x	Entretoise	740

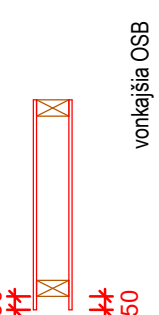
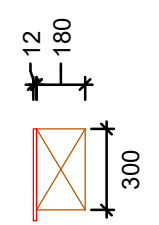
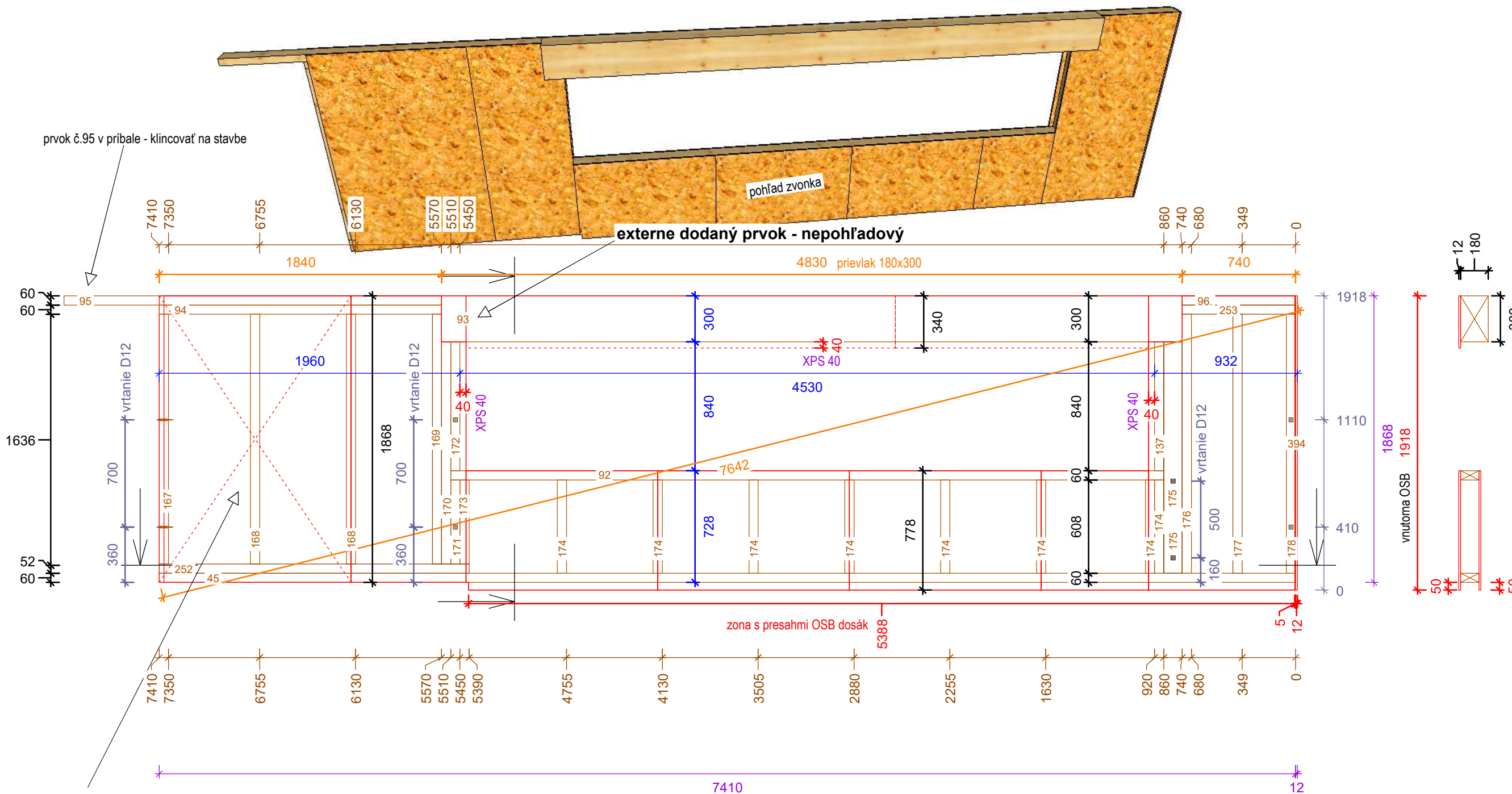

formát vnútornej OSB skrutkovať provizorne

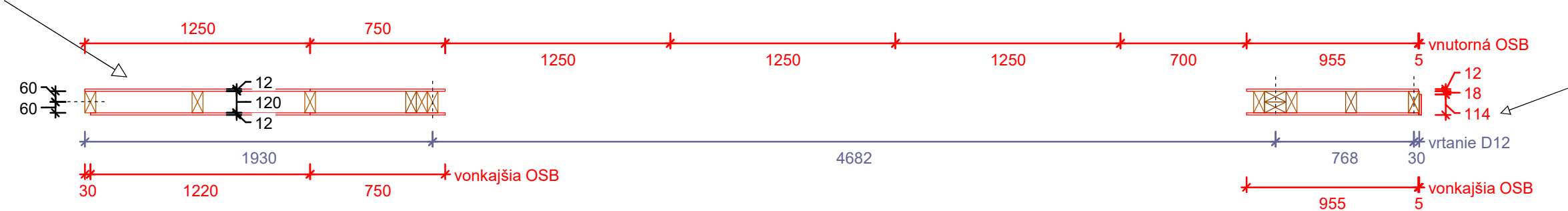

PO 0
Stěna 3
Rovina : -1, 0, 1, 3, 6
Pořadové číslo
Měřítko: 1 : 20

L187	1x	KVH, 120 x 60	817
L100	1x	Stojky	5112
L101	1x	Rám	5364
L183	1x	KVH, 60 x 120	160
L184	1x	Stojky	335
L185	1x	Stojky	526
L186	1x	Stojky	717
L188	1x	Stojky	908
L189	1x	Stojky	1099
L190	1x	Stojky	1290
L191	1x	Stojky	1481
L192	1x	Stojky	1672
L193	1x	Stojky	1705

60x120

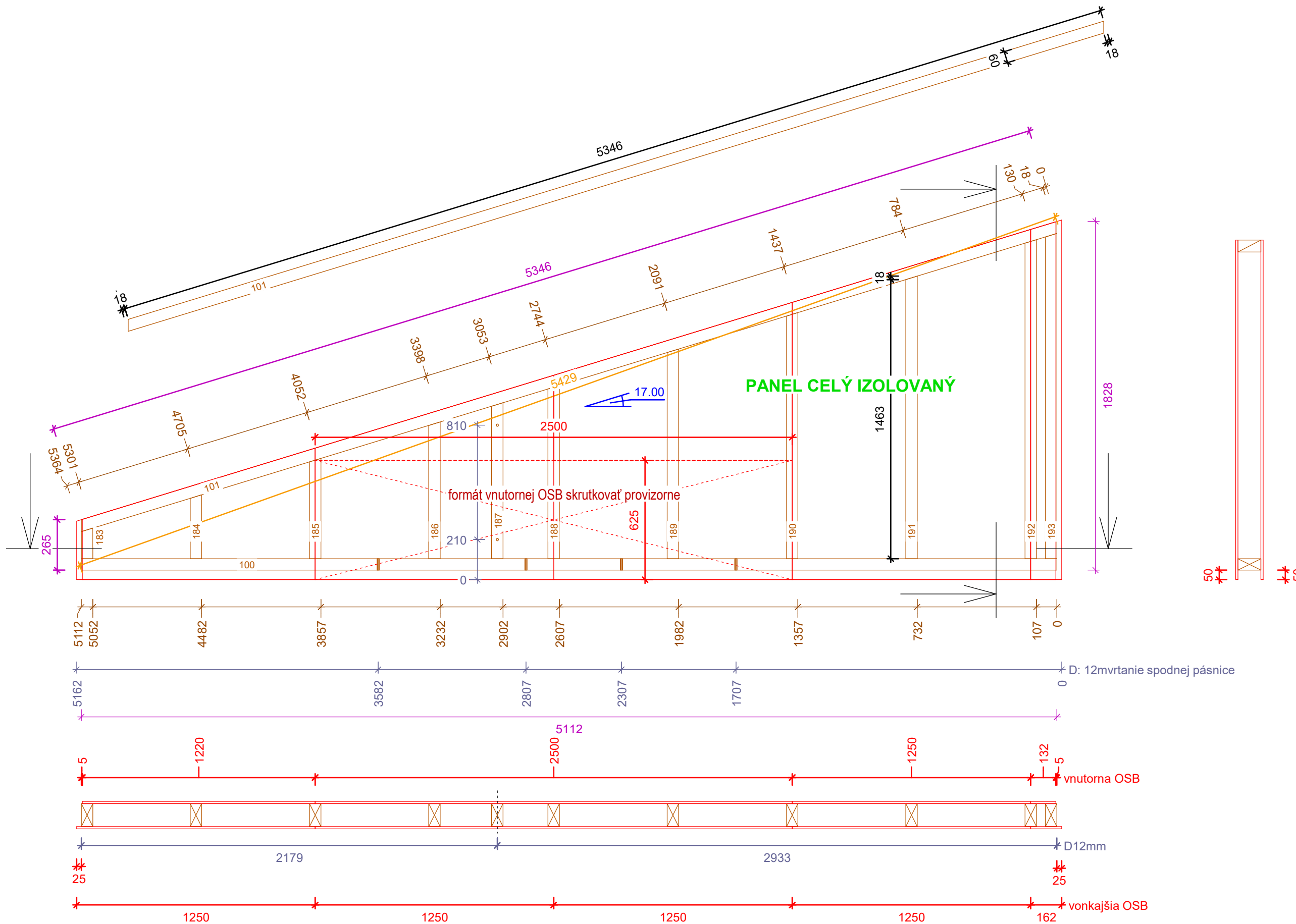

POHLAD NA PANEL ZVONIKA

PO 0
Stěna 4
Rovina : -1, 0, 1, 3, 6
Pořadové číslo
Měřítko: 1 : 18

L194	1x	KVH, 120 x 60	141
L196	1x	Stojky	201
L40	1x	KVH, 60 x 120	5328
L102	1x	Rám	4673
L195	1x	Stojky	141
L480	1x	Sloupky	201
L481	7x	Stojky	201
L482	1x	Entretoise	655

60x120

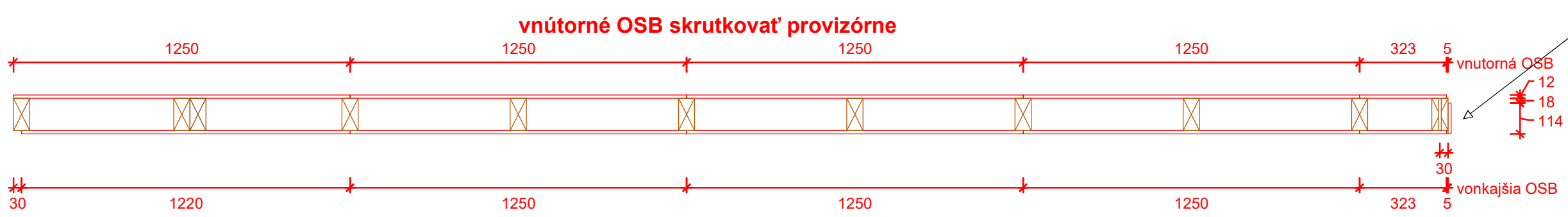
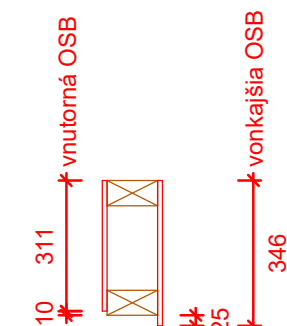
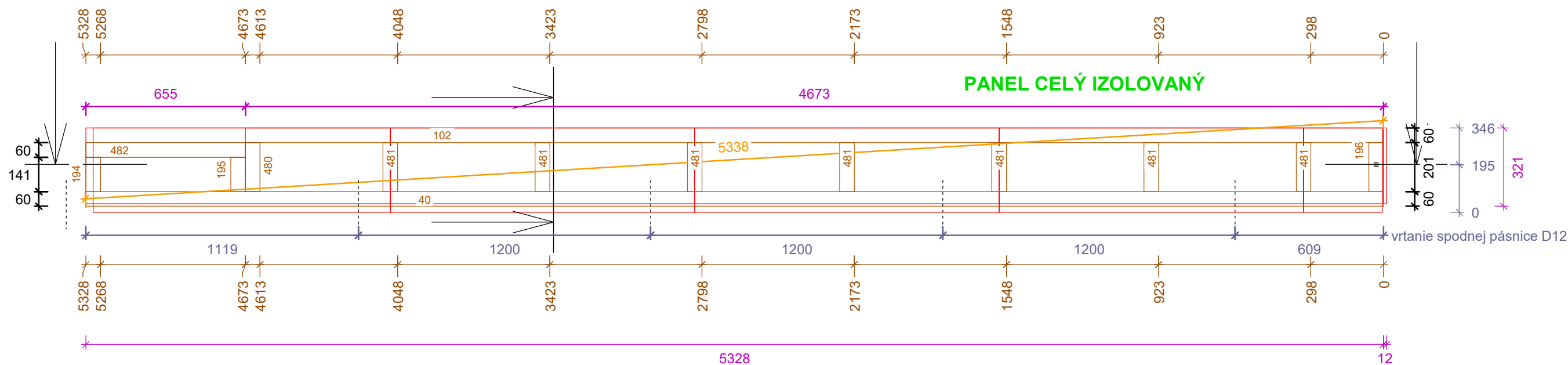

POHLAD NA PANEL ZVONKA

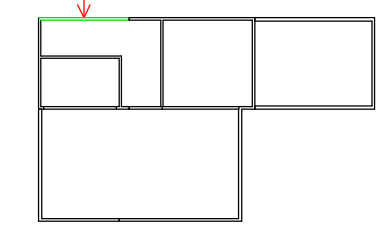

PO 0
Stěna 5
Rovina : -1, 0, 1, 3, 6
Pořadové číslo
Měřítko: 1 : 25

L196	1x	KVH, 120 x 60	201
		Stojky	
		KVH, 60 x 120	
L45	1x	Rám	7410
L103	1x	Rám	6285
L104	1x	Rám	1774
L195	3x	Stojky	141
L197	1x	Stojky	201
L480	1x	Sloupky	201
L481	9x	Stojky	201
L483	1x	Entretoise	1125

60x120

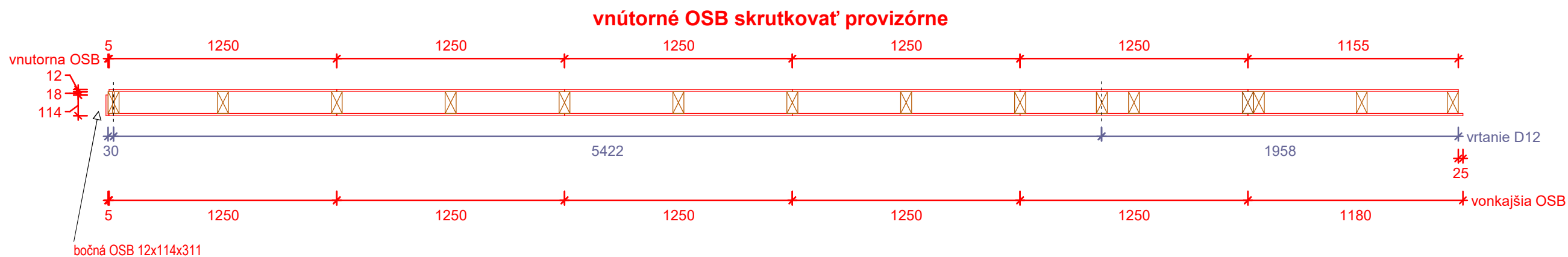
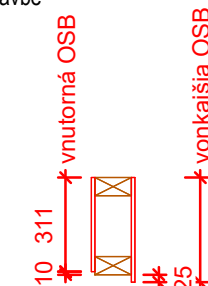
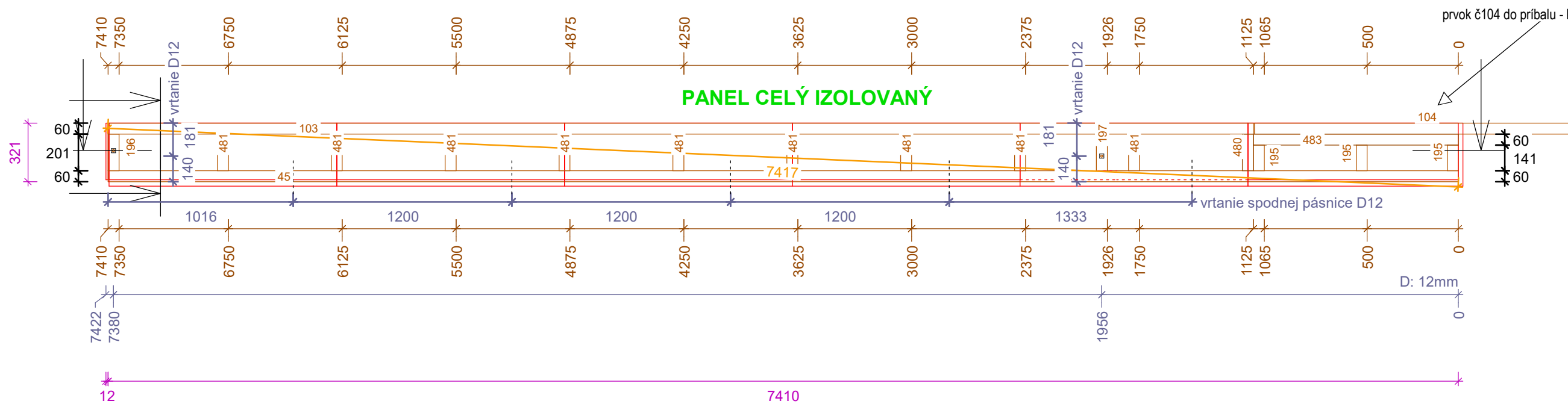

POHLAD NA PANEL ZVONKA

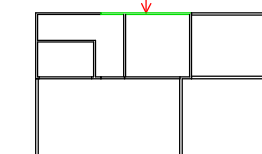

PO 0
 Stěna 6
 Rovina : -1, 0, 1, 3, 6
 Pořadové číslo
 Měřítko: 1 : 20

PANEL CELÝ IZOLOVANÝ

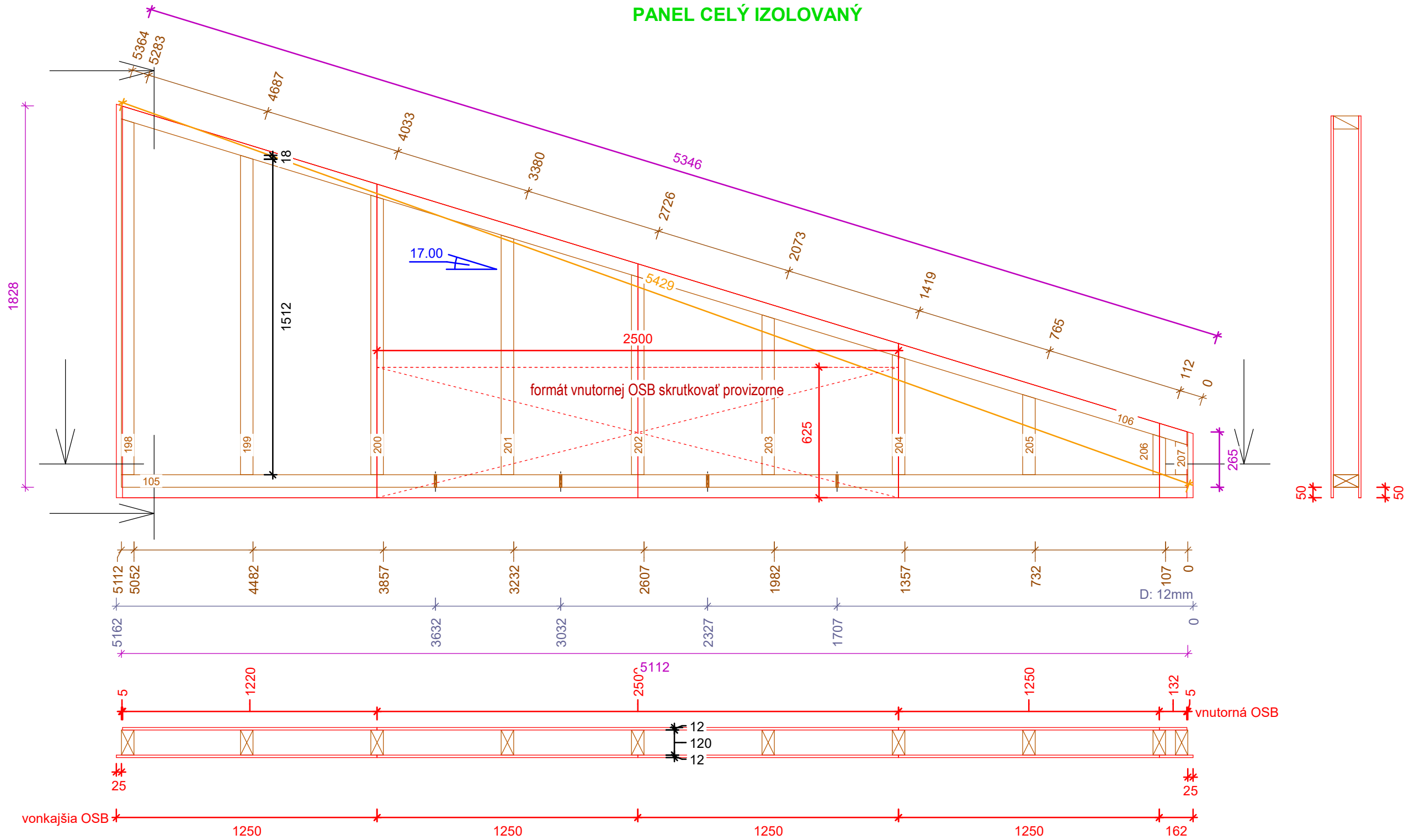

Code	Quantity	Description	Value
L105	1x	KVH, 60 x 120	5112
L106	1x	Rám	5364
L198	1x	Stojky	1705
L199	1x	Stojky	1531
L200	1x	Stojky	1339
L201	1x	Stojky	1148
L202	1x	Stojky	957
L203	1x	Stojky	766
L204	1x	Stojky	575
L205	1x	Stojky	384
L206	1x	Stojky	193
L207	1x	Stojky	160

60x120

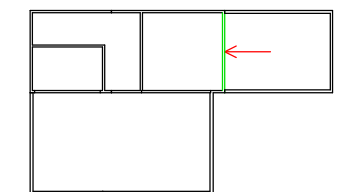

POHLAD NA PANEL ZVONKA

PO 0
Stěna 7
Rovina : -1, 0, 1, 3, 6
Pořadové číslo
Měřítko: 1 : 22

L208	12x	KVH, rošty 60 x 60	246
L107	1x	Stojky	6450
L108	2x	KVH, 60 x 120	6450
L209	12x	Rám	652
		Stojky	652

PANEL NEIZOLOVAŤ

60x120

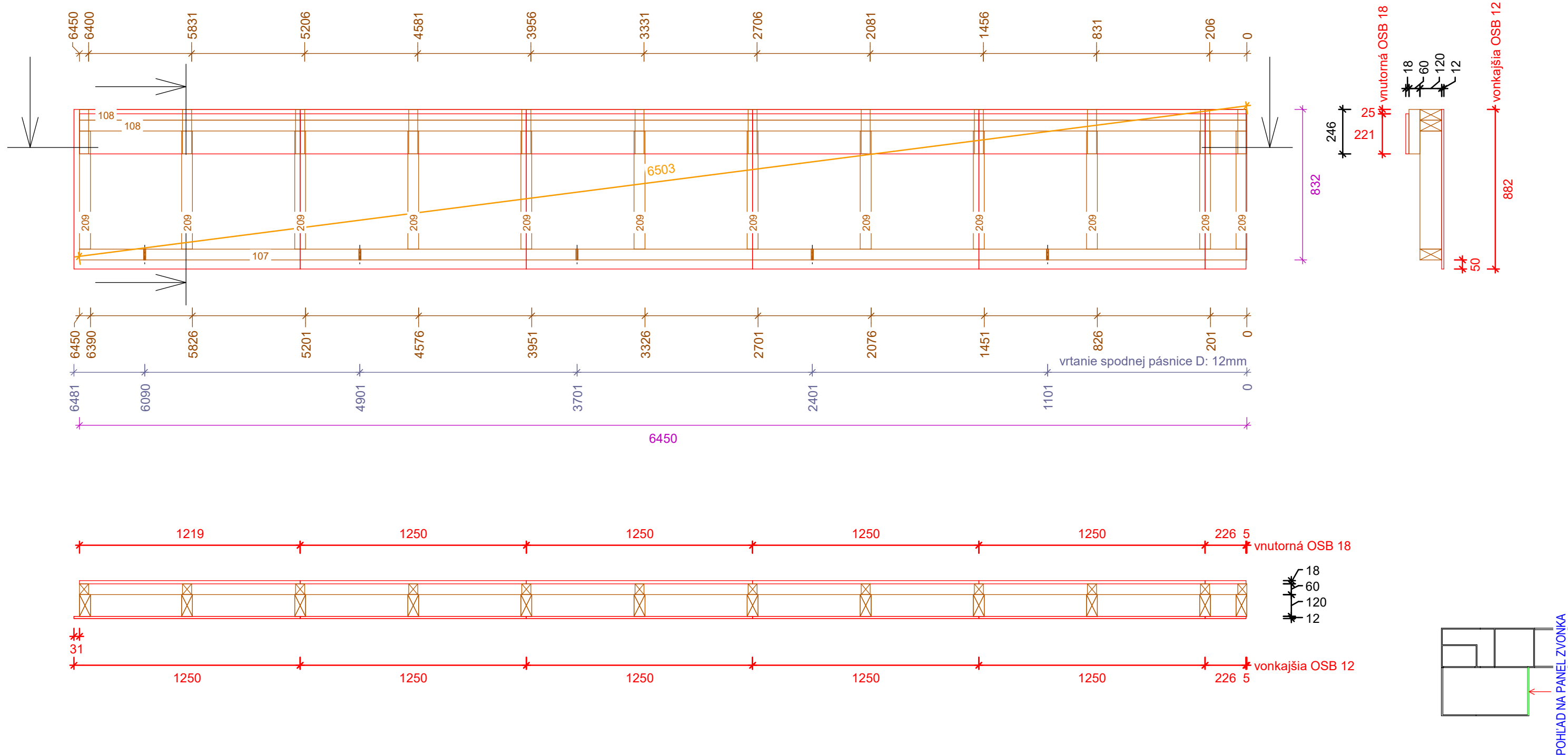

PO 0
Stěna 8
Rovina : -1, 0, 1, 3, 6
Pořadové číslo
Měřítko: 1 : 25

L1	1x	KVH, 60 x 220	7091
		Trám	
L210	1x	KVH, 120 x 60	652
		Stojky	
L109	1x	KVH, 60 x 120	7223
L110	1x	Rám	7223
L111	1x	Rám	6168
L209	12x	Stojky	652
L255	1x	Entretoise	3340

PANEL CELÝ IZOLOVANÝ

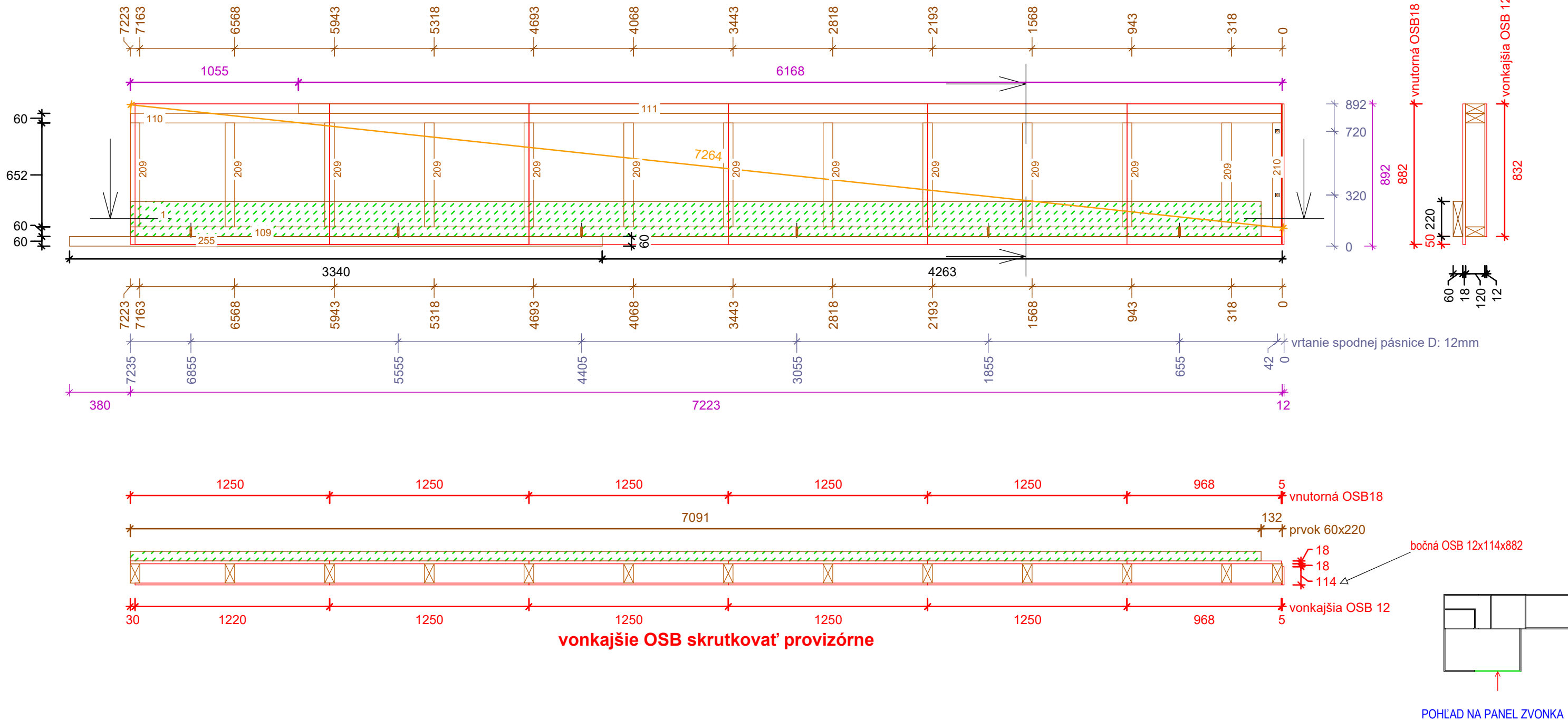

PO 0
 Stěna 9
 Rovina : -1, 0, 1, 3, 6
 Pořadové číslo
 Měřítko: 1 : 22

L2	1x	KVH, 60 x 220	4621
L210	1x	Trám	652
L211	1x	KVH, 120 x 60	652
L112	1x	Stojky	4753
L113	1x	Stojky	4753
L114	1x	KVH, 60 x 120	3260
L115	1x	Rám	2543
L209	7x	Rám	652

PANEL CELÝ IZOLOVANÝ

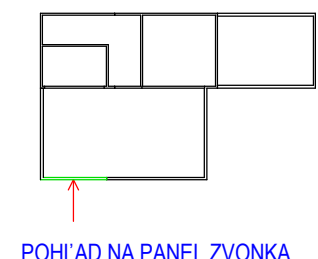
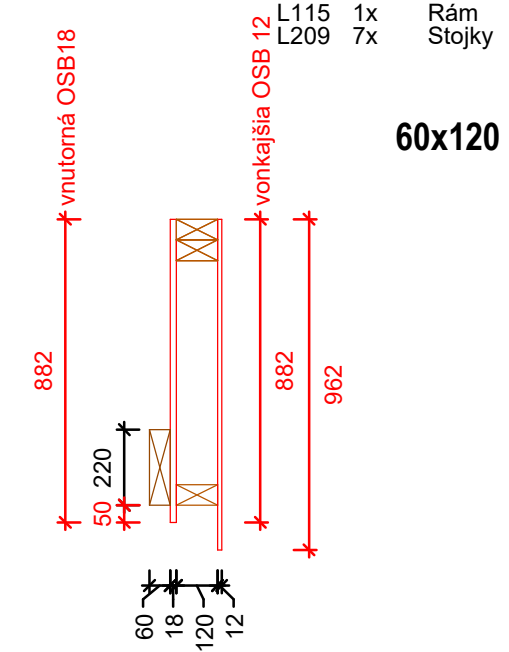
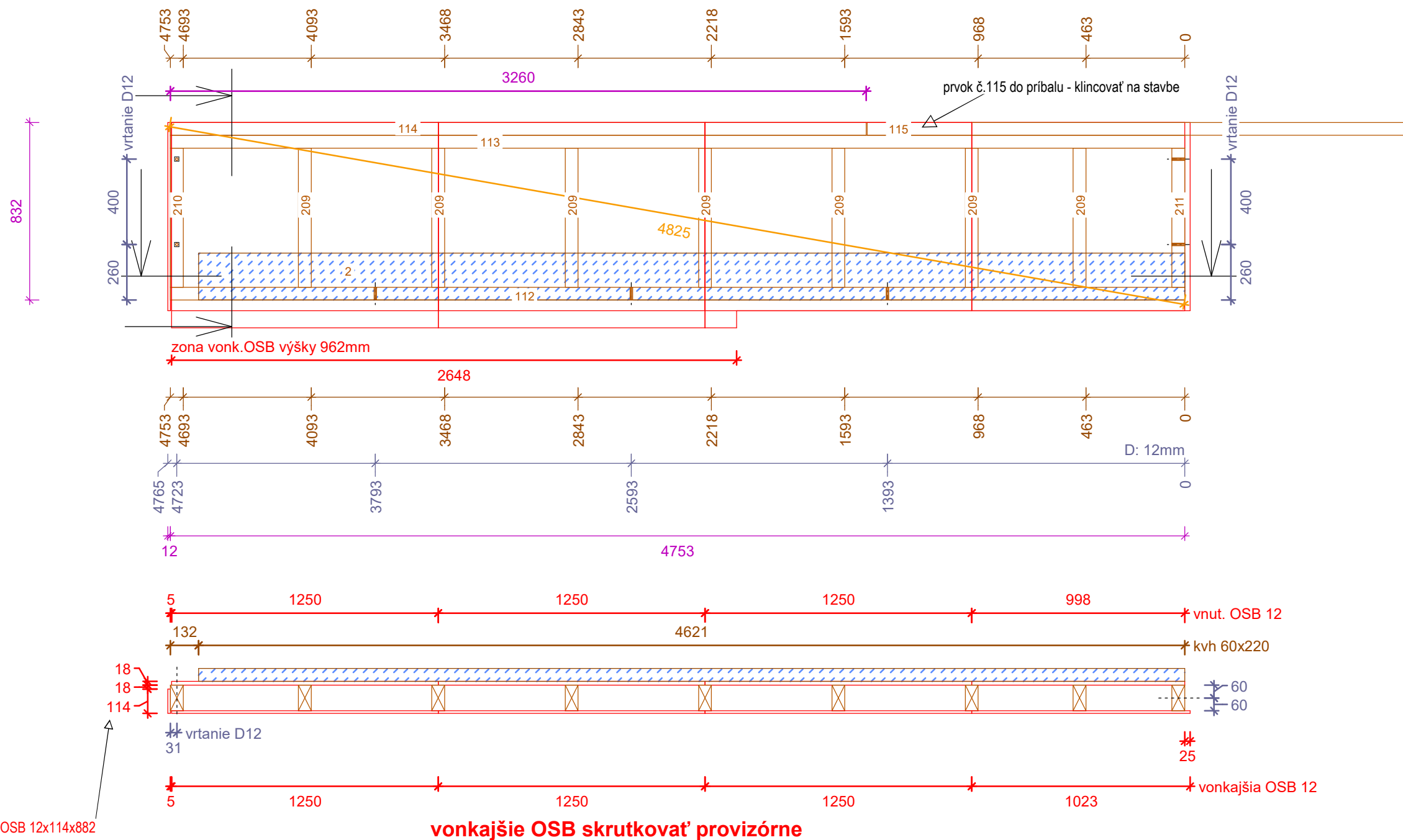

PO 0
Stěna 10
Rovina : -1, 0, 1, 3, 6
Pořadové číslo
Měřítko: 1 : 22

L212	12x	KVH, 50 x 50	245
		Stojky	
L108	3x	KVH, 60 x 120	6450
		Rám	
L209	11x	Stojky	652
L213	1x	Stojky	652

60x120

PANEL NEIZOLOVAĎ

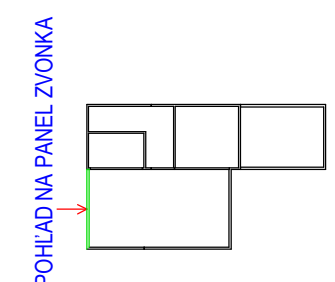
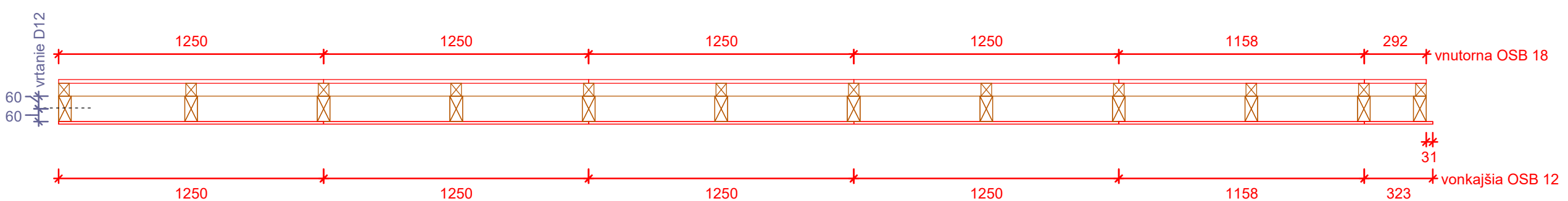
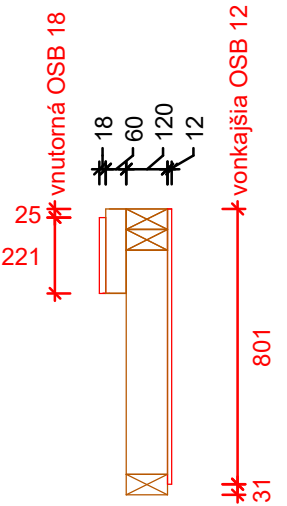
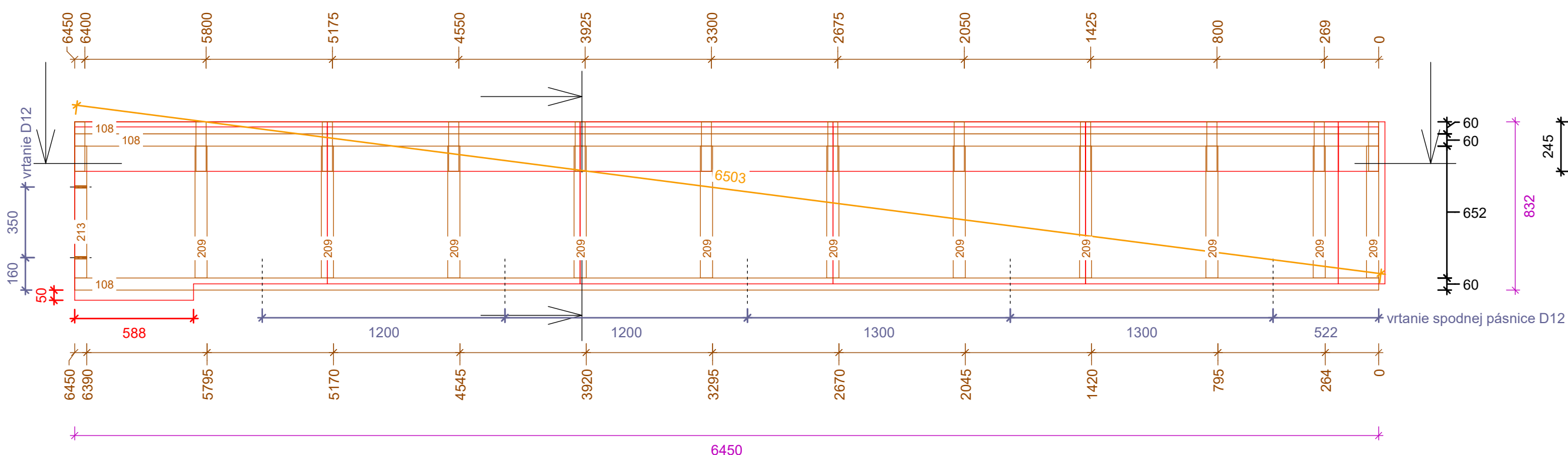

PO 0
 Stěna 11
 Rovina : -1, 0, 1, 3, 4, 6
 Pořadové číslo
 Měřítko: 1 : 22

L214	1x	KVH, 50 x 50	314
L216	1x	Stojky	328
L217	1x	Stojky	340
L218	1x	Stojky	353
L219	1x	Stojky	365
L220	1x	Stojky	378
L221	1x	Stojky	391
L222	1x	Stojky	403
L223	1x	Stojky	416
L224	1x	Stojky	428
L225	1x	Stojky	441
L226	1x	Stojky	452
		KVH, 60 x 120	
L116	1x	Rám	6913
L117	2x	Rám	6913
L215	13x	Stojky	537

PANEL NEIZOLOVAŤ

POHLAD NA PANEL ZVONKA

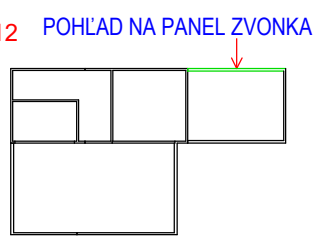
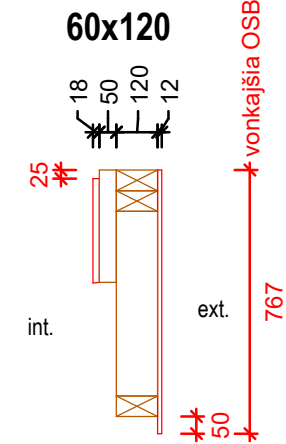
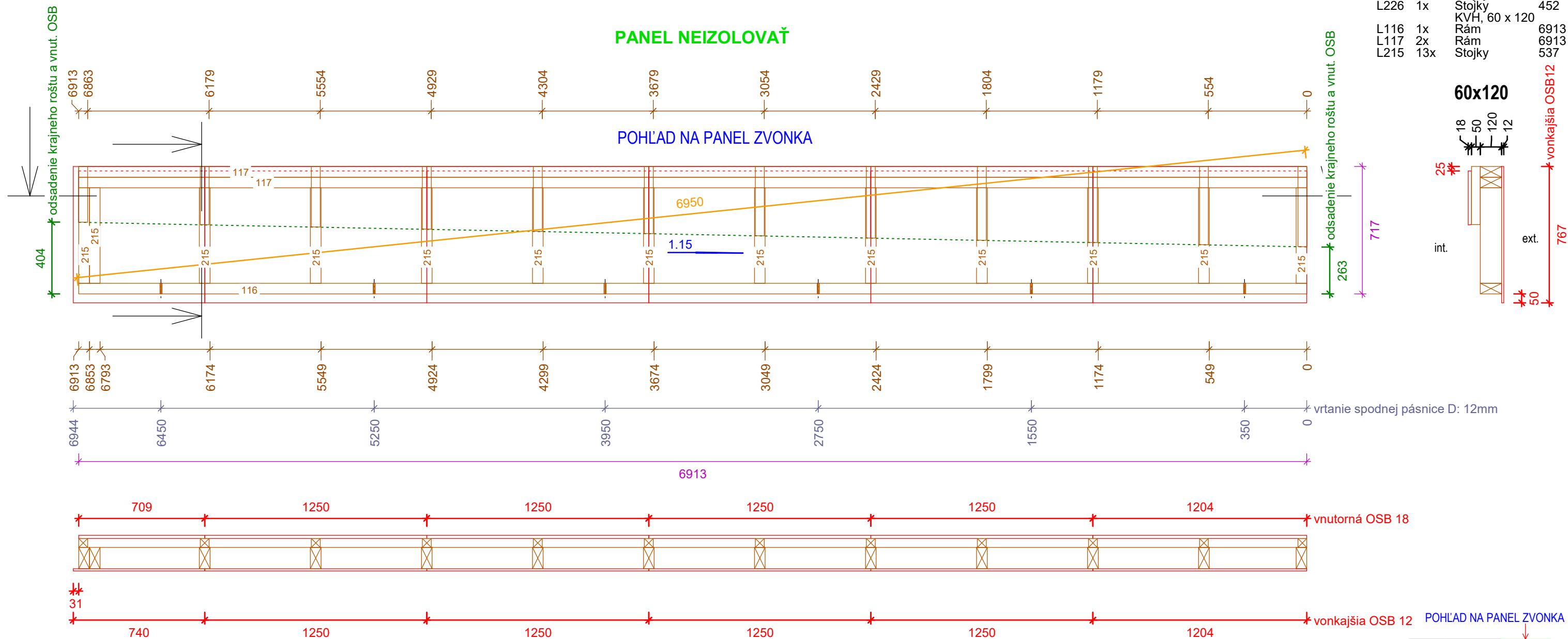

PO 0
Stěna 12
Rovina : -1, 0, 1, 3, 6
Pořadové číslo
Měřítko: 1 : 20

L119	1x	KVH, 50 x 50	5011
		Rám	
L227	2x	KVH, 120 x 60	537
		Stojky	
L118	1x	Rám	5376
L120	2x	Rám	5376
L215	9x	Stojky	537

PANEL CELÝ IZOLOVANÝ

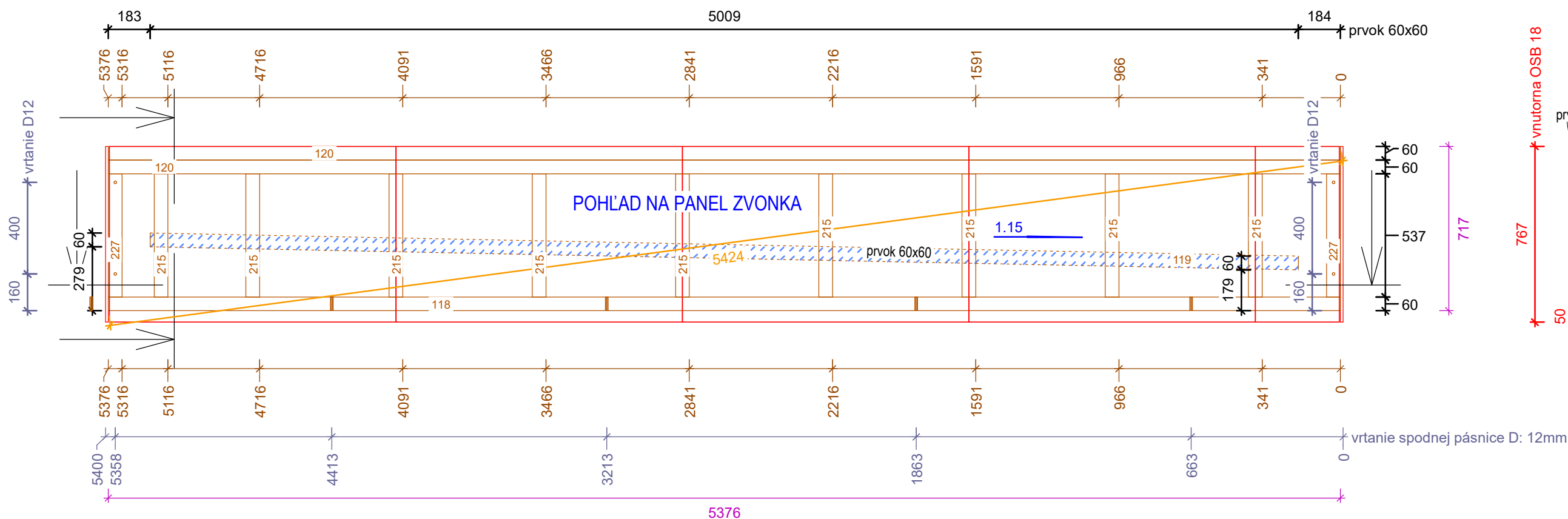

60x120

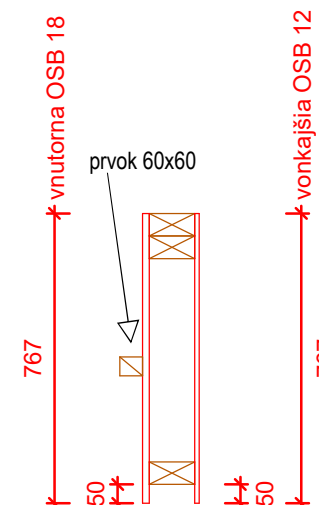

bočná OSB 12x114x767

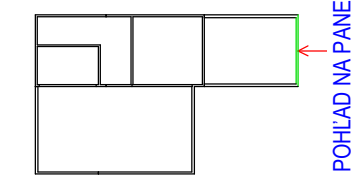
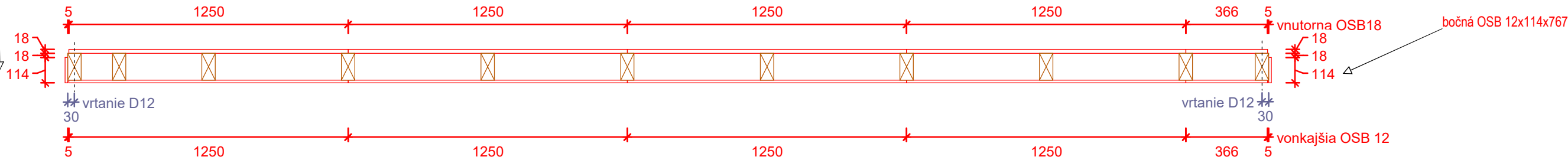

POHLAD NA PANEL ZVONKA

PO 0
Stěna 13
Rovina : -1, 0, 1, 3, 4, 6
Pořadové číslo
Měřítko: 1 : 23

L228	12x	KVH, 50 x 50	351
L117	2x	Stojky	6913
L121	1x	KVH, 60 x 120	6913
L125	13x	Rám	537
		Stojky	537

POZOR - všetky formáty vonkajšej OSB 12 dať do príbalu!

PANEL NEIZOLOVAŤ

60x120

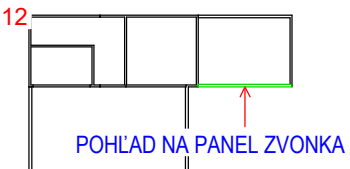
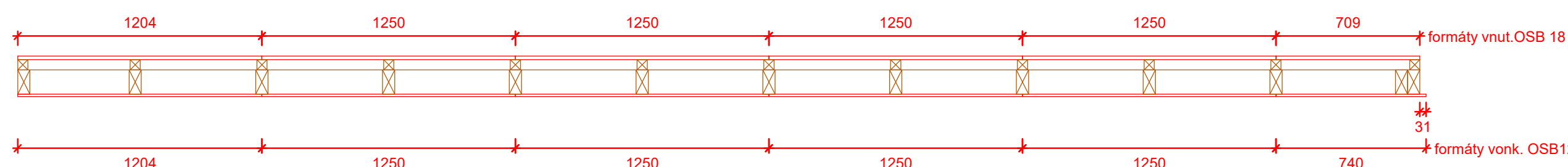
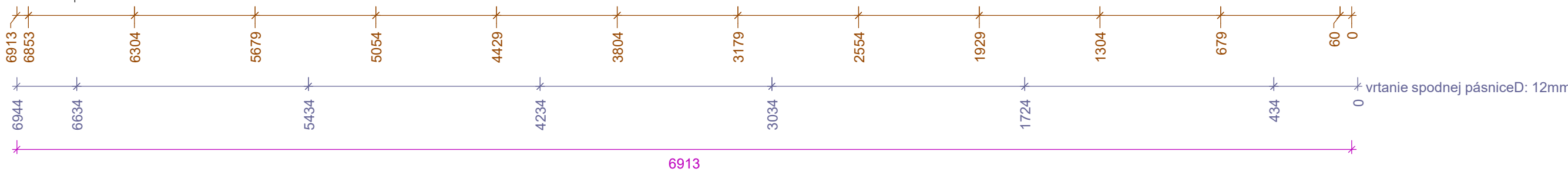
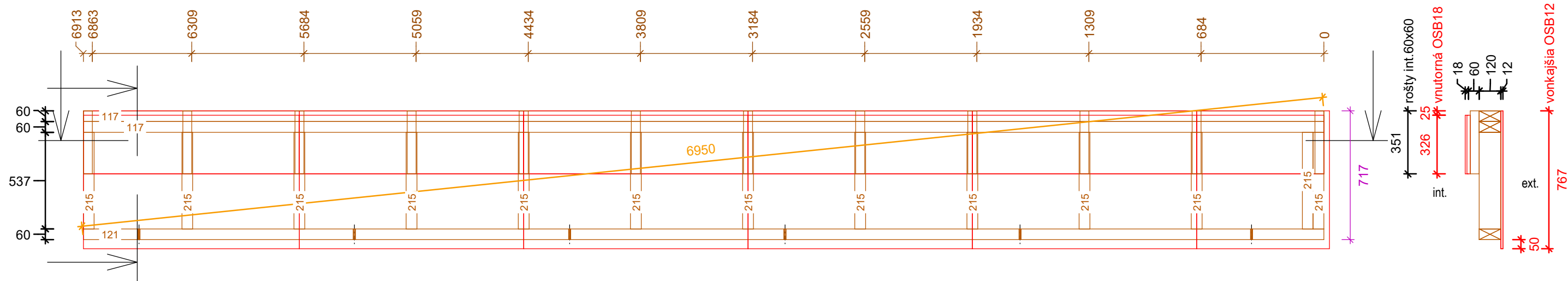

PANEL BEZ IZOLÁCIE

PO 0
Stěna 14
Rovina : -1, 0, 1, 3, 6
Pořadové číslo
Měřítko: 1 : 18

POZOR - všetky formáty vonkajšej OSB 12 len skrutkovať provizórne v dielni

		KVH, 60 x 100	
L122	1x	Rám	4741
L229	1x	Stojky	4741
L231	7x	Stojky	770
L484	1x	Entretoise	4741
		KVH, 100 x 60	
L230	1x	Stojky	770
L232	1x	Stojky	770

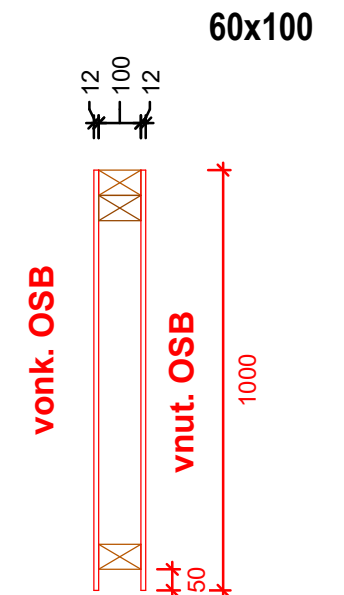
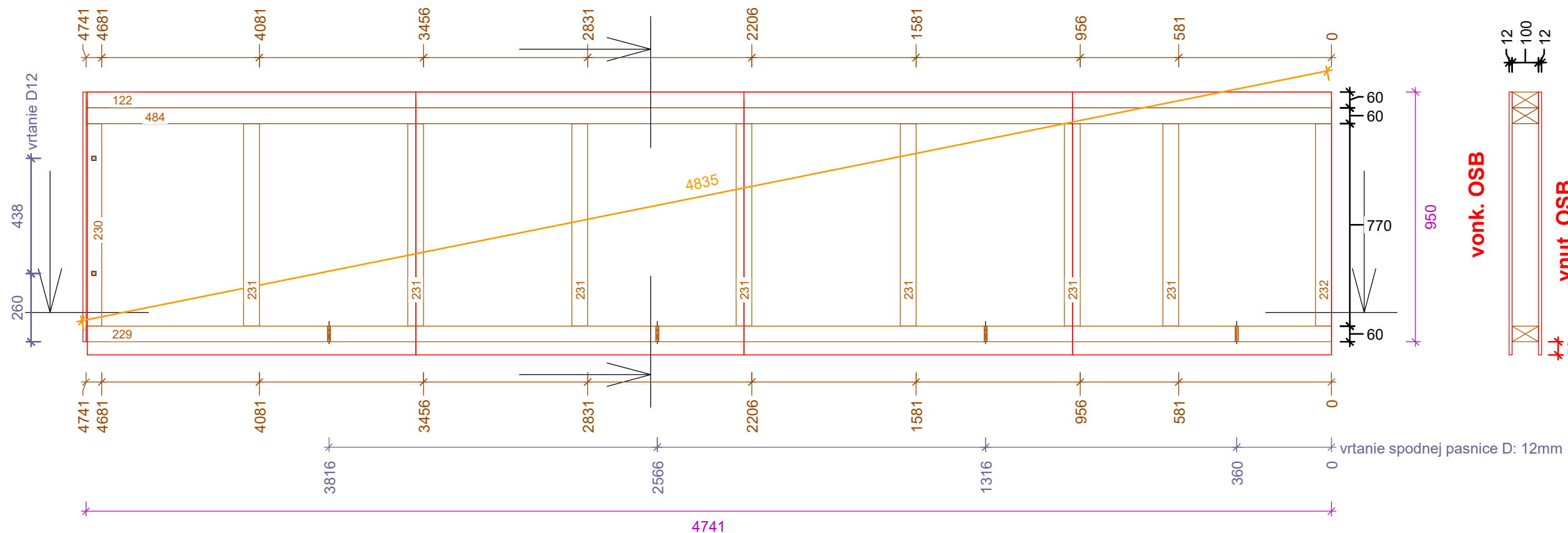

bočná OSB 12x94x950

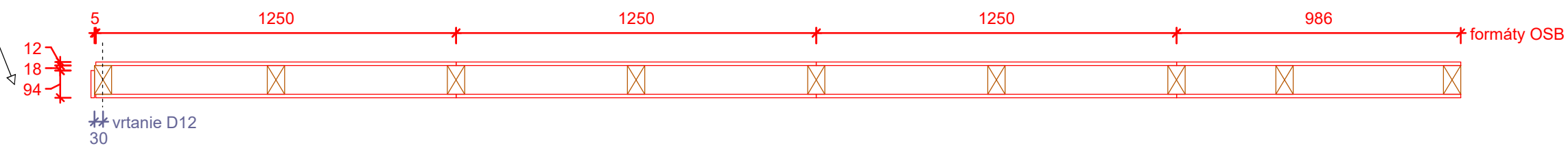

POHLAD NA PANEL V SMERE ŠÍPKY

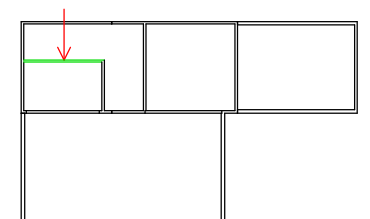

PO 0
 Stěna 15
 Rovina : -1, 0, 1, 3, 6
 Pořadové číslo
 Měřítko: 1 : 18

		KVH, 60 x 120	
L123	1x	Rám	2870
L124	1x	Rám	3019
L198	1x	Stojky	1705
L233	1x	Stojky	1521
L234	1x	Stojky	1330
L235	1x	Stojky	1139
L236	1x	Stojky	948
L237	1x	Stojky	846

60x120

PANEL CELÝ IZOLOVANÝ

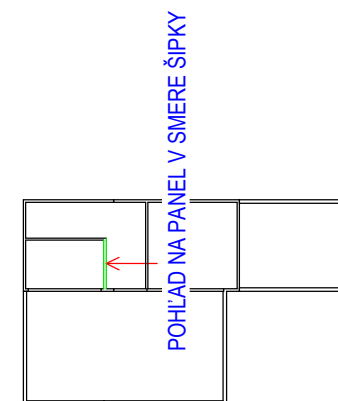
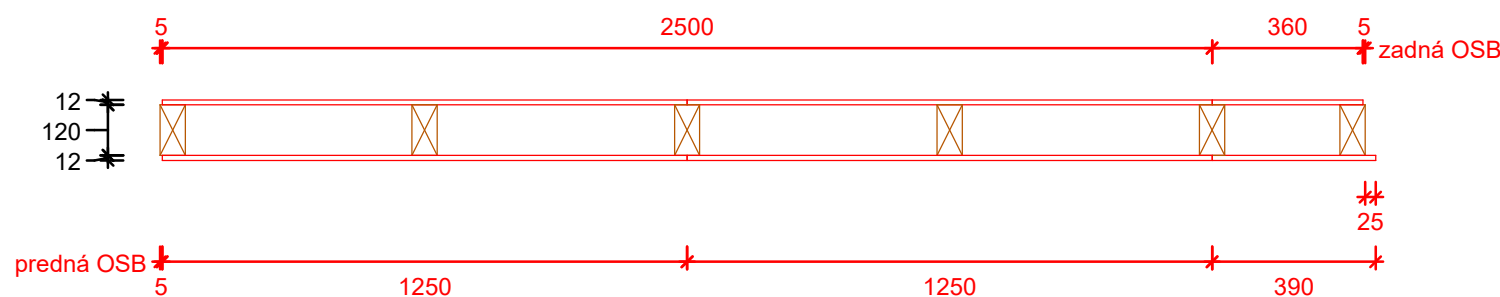
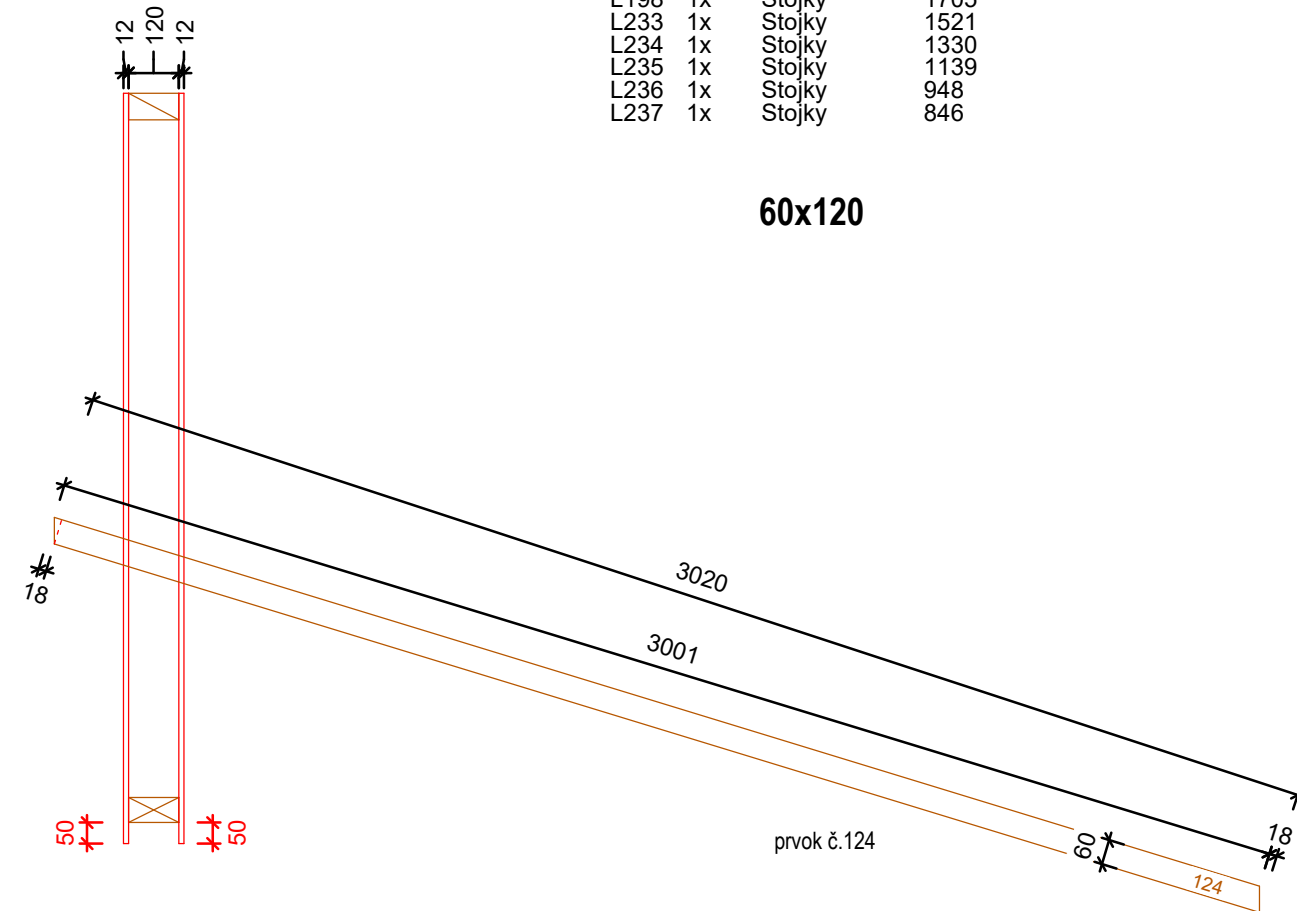
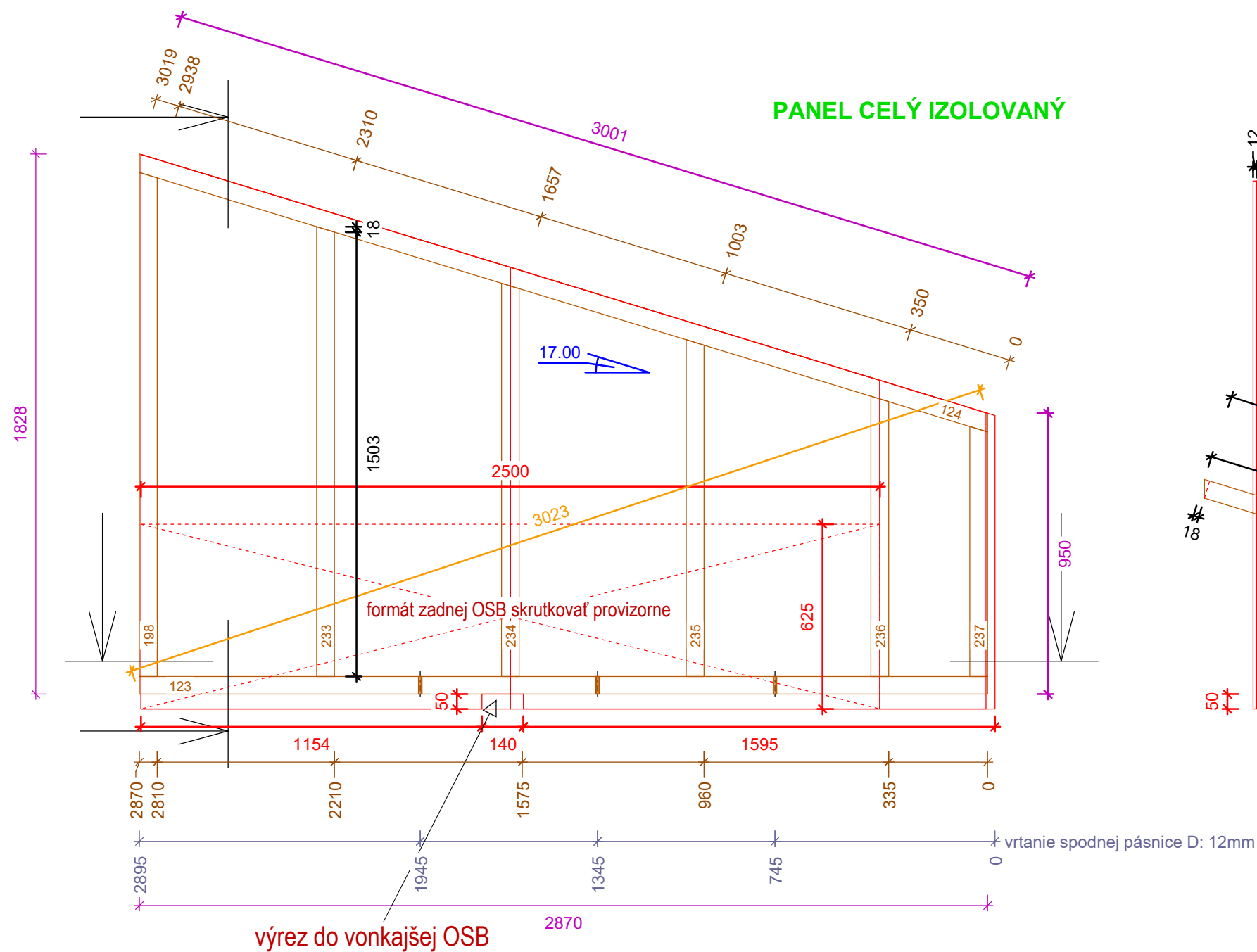

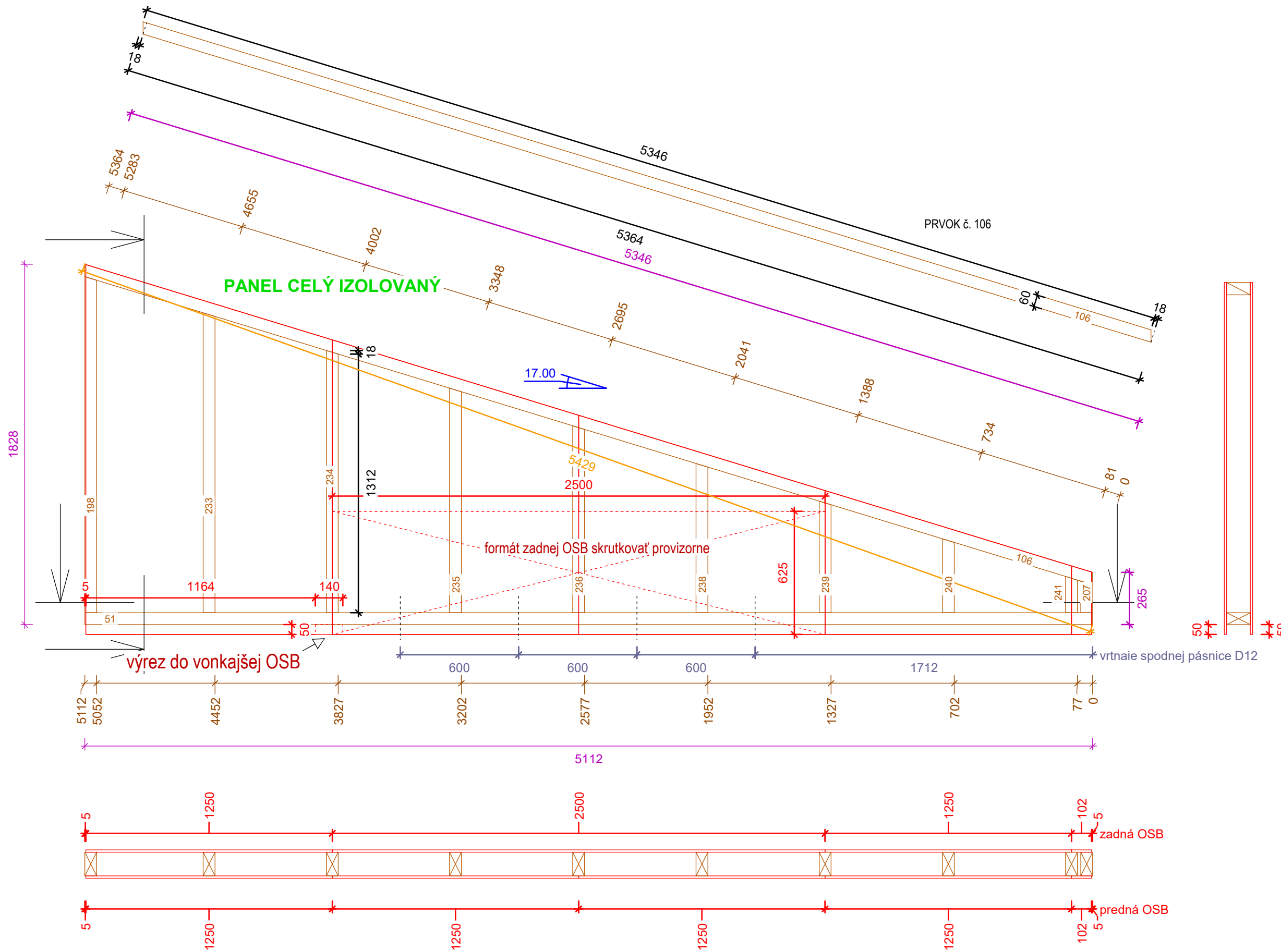

PO 0
 Stěna 16
 Rovina : -1, 0, 1, 3, 6
 Pořadové číslo
 Měřítko: 1 : 20

L51	1x	KVH, 60 x 120	5112
L106	1x	Rám	5364
L198	1x	Stojky	1705
L207	1x	Stojky	160
L233	1x	Stojky	1521
L234	1x	Stojky	1330
L235	1x	Stojky	1139
L236	1x	Stojky	948
L238	1x	Stojky	757
L239	1x	Stojky	566
L240	1x	Stojky	375
L241	1x	Stojky	184

60x120

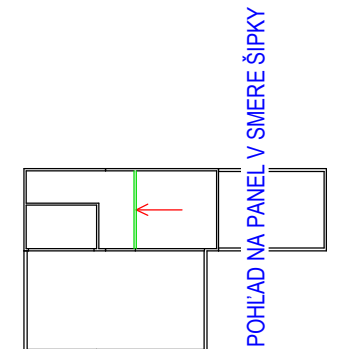

stropné zostavy I. vyrobiť 11ks zostáv

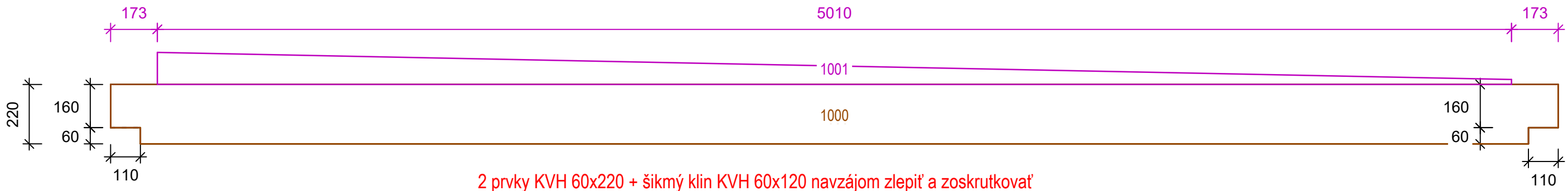

2 prvky KVH 60x220 + šikmý klin KVH 60x120 navzájom zlepiť a zoskrutkovať

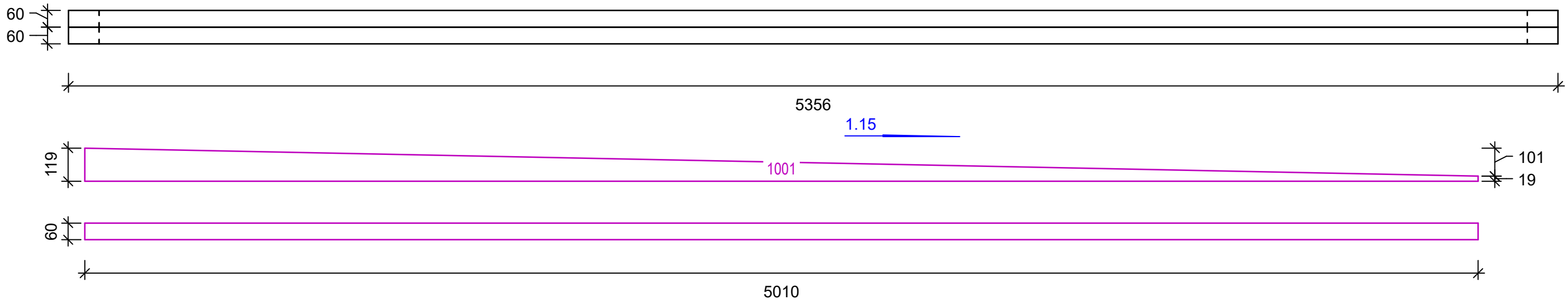

spádový prvok č.1002 - KVH 60x114x5231 1ks

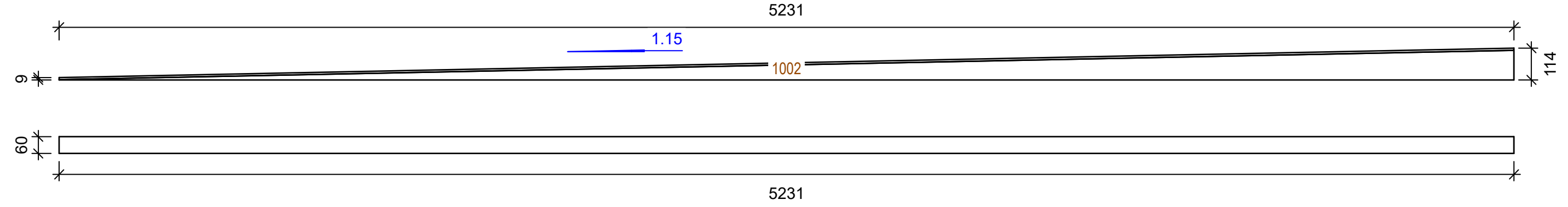

spádový prvok č.1003 - KVH 60x64x2731..... 1ks

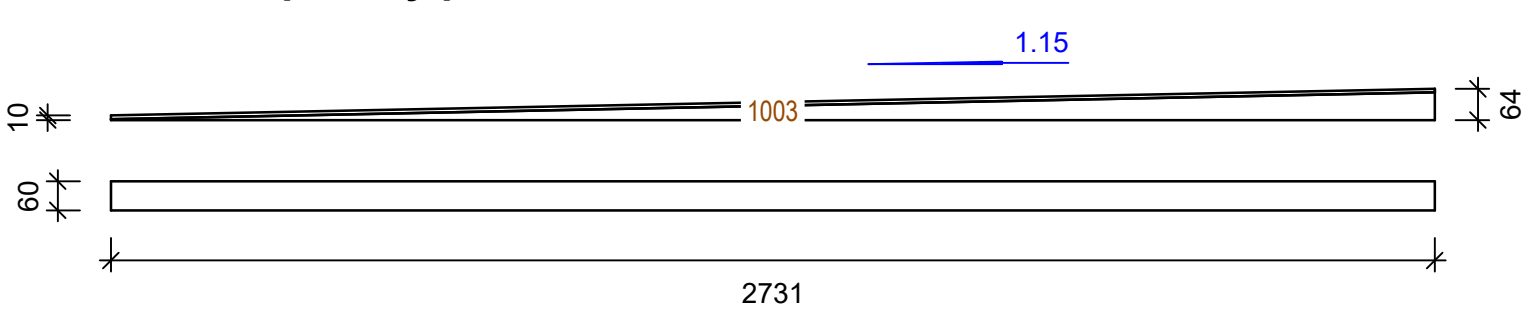

A	10-10-2017		CM
indice	date	modifications	nom

Projet: RD Zábojníkovci	Carnet: 06-200 (plancad n° 200)	Echelle: 1/10°
Nom du plan: prvky garažovej strechy		Maitre d'ouvrage:
Chargé d'Affaire:	Dessinateur:	

predpokladané miesto vpuste

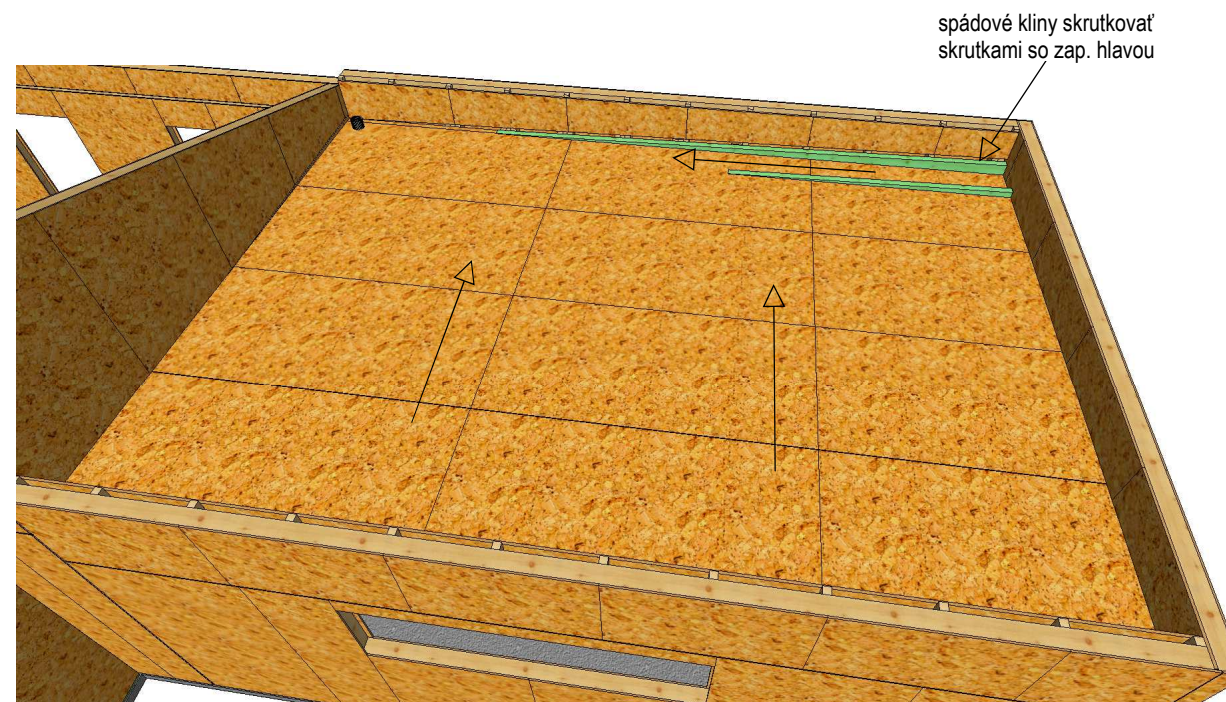
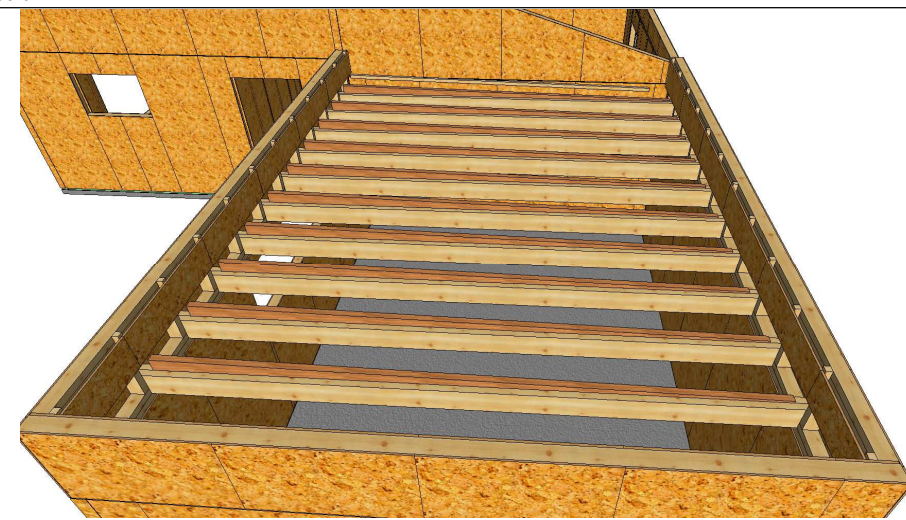
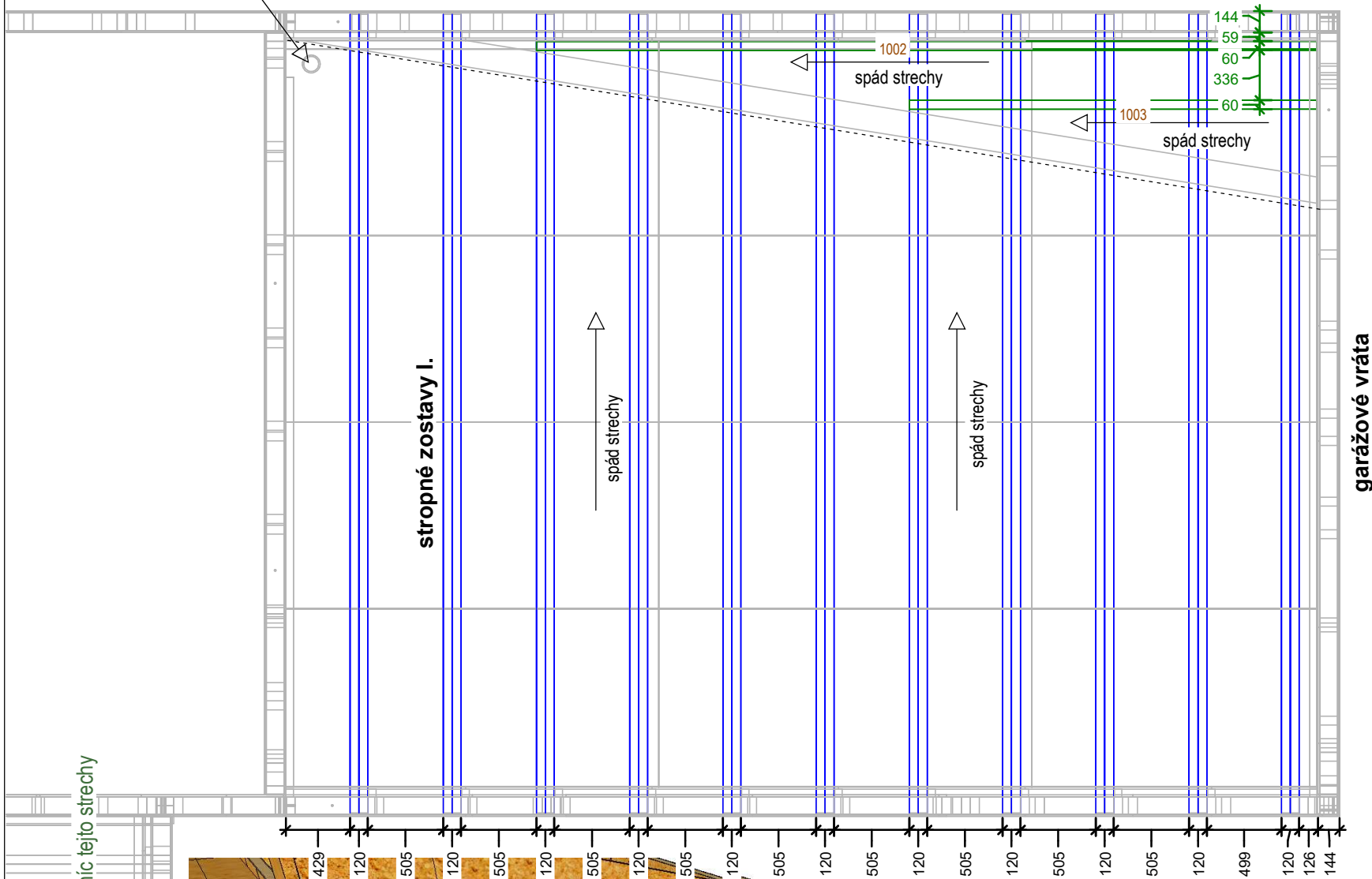

panel s vonk. OSB v príbale - kvôli pokladke stropnic tejto strechy následne potom vonk. OSB klincovať na stavbe

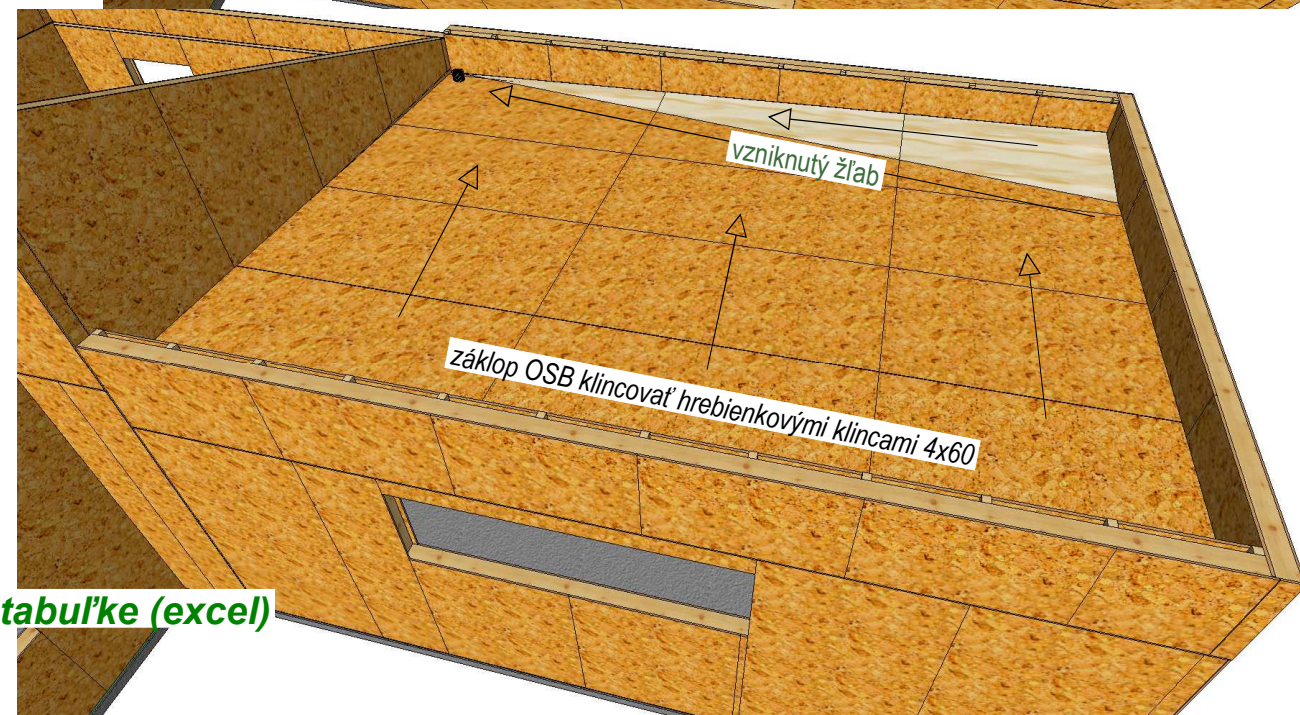
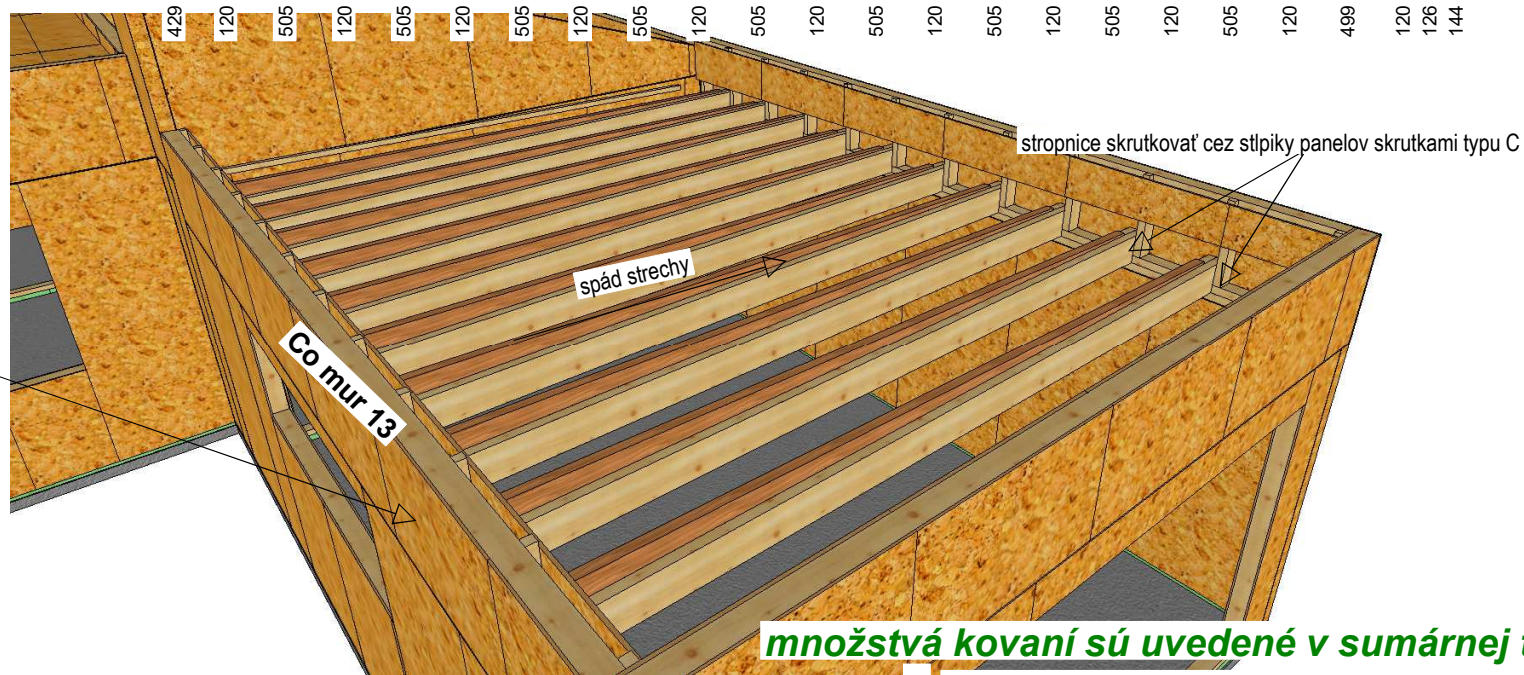

množstvá kovaní sú uvedené v sumárnej tabuľke (excel)

C - skrutka 12x140 + podložka DIAM 13
hrebienkové klincei 4x60

indice	date	modifications	nom
A	13-10-2017		CM

Projet: RD Zábojníkovci	Carnet: 201 (placard n° 201)	Echelle: 1/10°
Maitre d'ouvrage:	Chargé d'Affaire:	N° d'affaire:
Nom du plan: garážová atiková strecha		
Dessinateur:		

dôležité zaizolovať so stropom aj časť atikových panelov

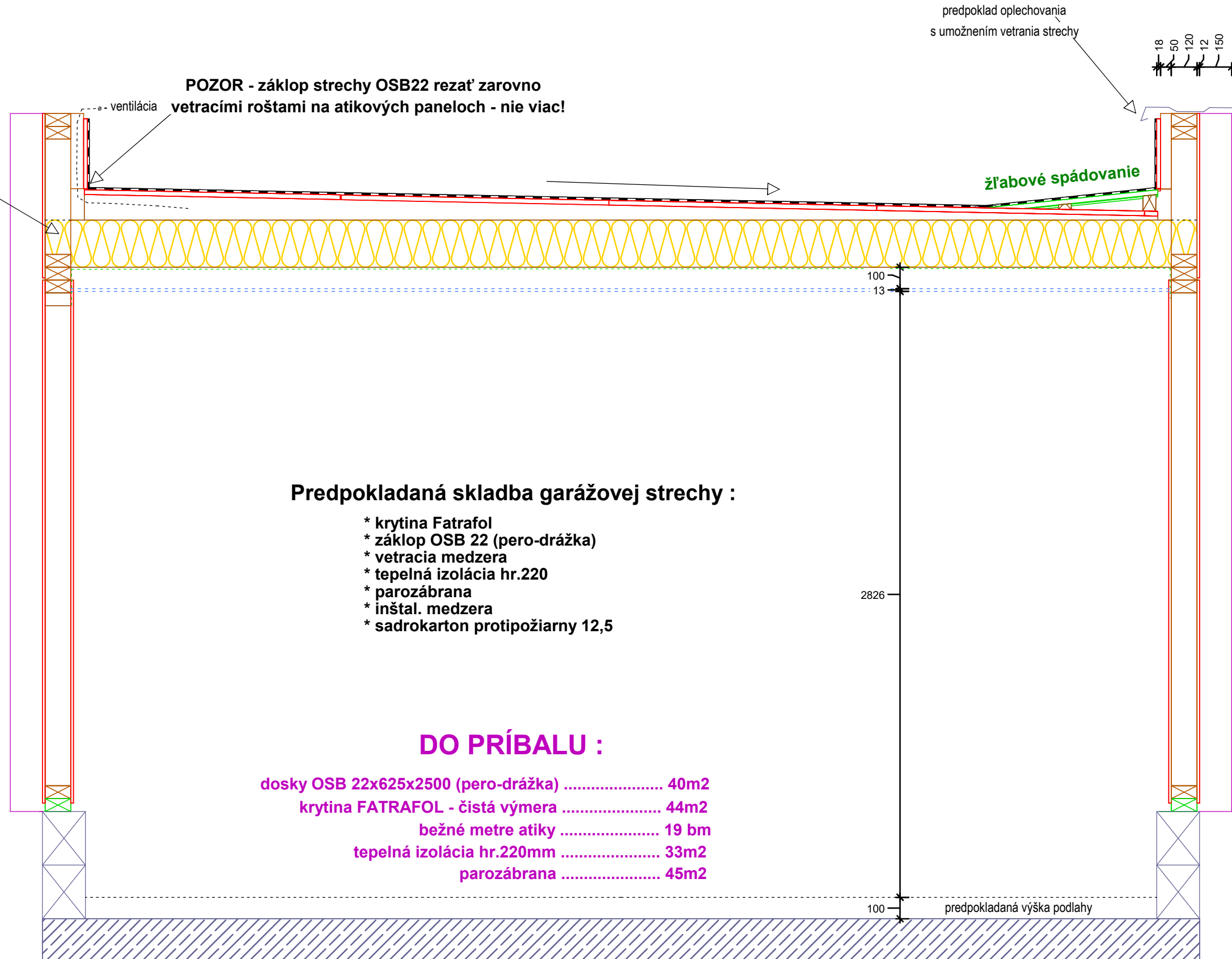

Predpokladaná skladba garážovej strechy :

- * krytina Fatrafol
- * záklop OSB 22 (pero-drážka)
- * vetracia medzera
- * tepelná izolácia hr.220
- * parozábrana
- * inštal. medzera
- * sadrokarton protipožiarny 12,5

DO PRÍBALU :

- dosky OSB 22x625x2500 (pero-drážka) 40m²
- krytina FATRAFOL - čistá výmera 44m²
- bežné metre atiky 19 bm
- tepelná izolácia hr.220mm 33m²
- parozábrana 45m²

A	13-10-2017		CM
indice	date	modifications	nom

Projet: RD Zábojníkovci	Carnet: 202 (placard n° 202)	Echelle: 1/10°
Maitre d'ouvrage:	Chargé d'Affaire:	N° d'affaire:
Nom du plan: ukončenie garážovej strechy		
Dessinateur:		

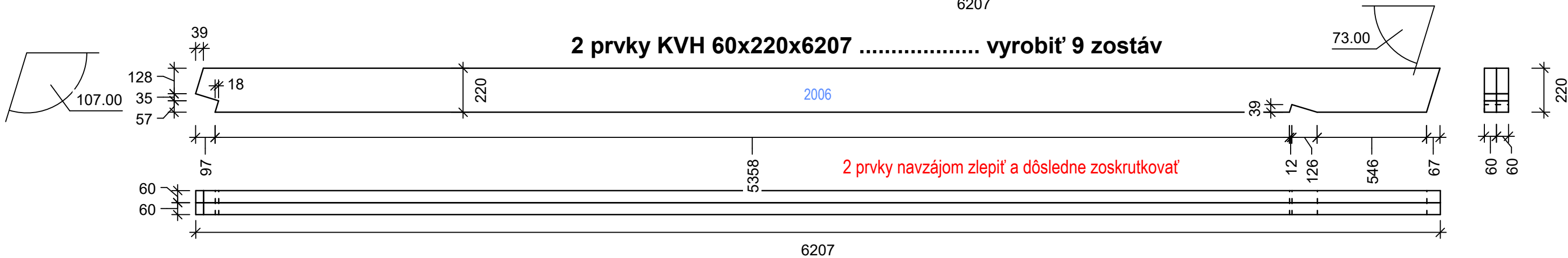
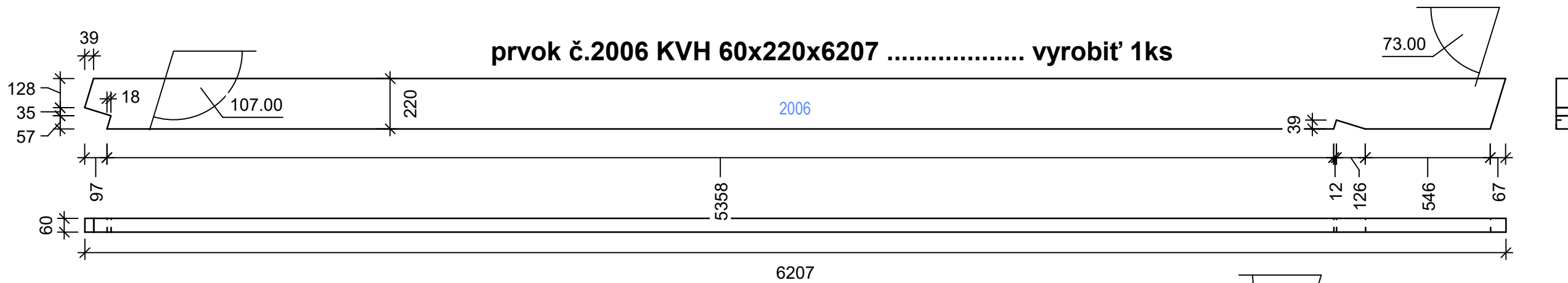
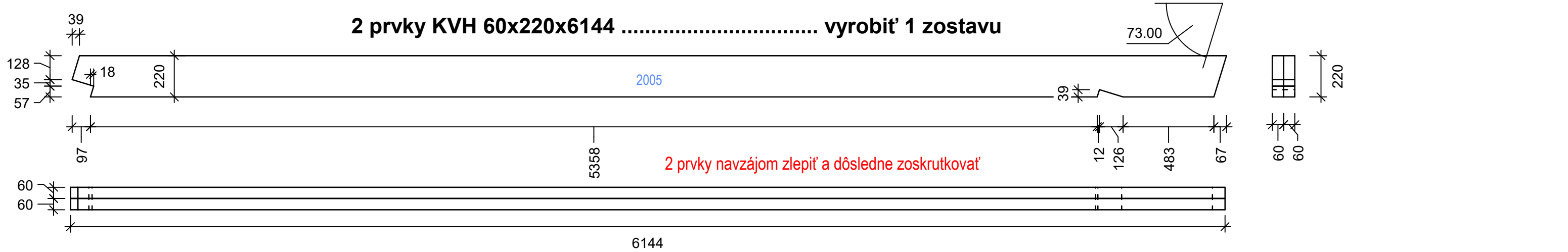

prvok č.2000 KVH 60x220x1307..... vyrobiť 9ks

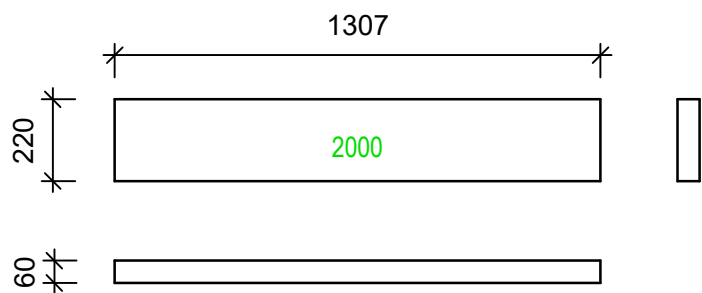

prvok č.2001 KVH 60x220x1407..... vyrobiť 9ks

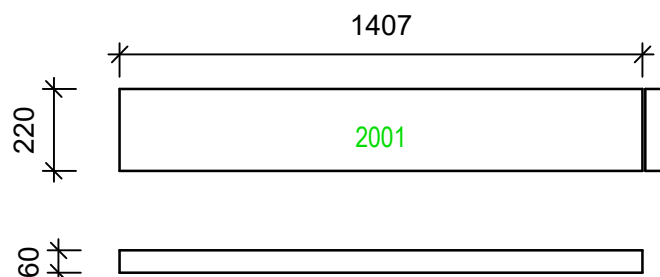

prvok č.2002 KVH 60x220x1487..... vyrobiť 1ks

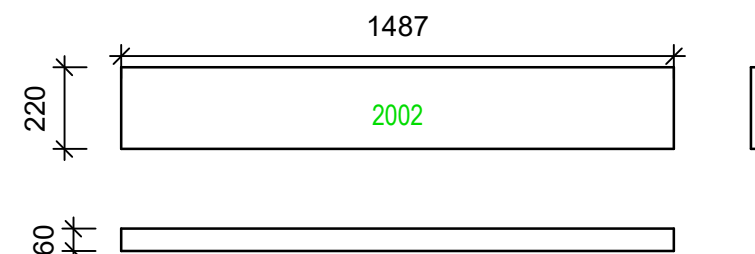

A	11-10-2017		CM
indice	date	modifications	nom

Projet: RD Zábojníkovci	Carnet: 06-205 (plancad n° 205)	Echelle: 1/10°
Nom du plan: prvky I.hlavnej šikmej strechy		Maitre d'ouvrage:
Chargé d'Affaire:	Dessinateur:	

prvok č.2006 KVH 60x220x5865 vyrobiť 1ks

prvok č.2002 KVH 60x220x1587..... vyrobiť 1ks

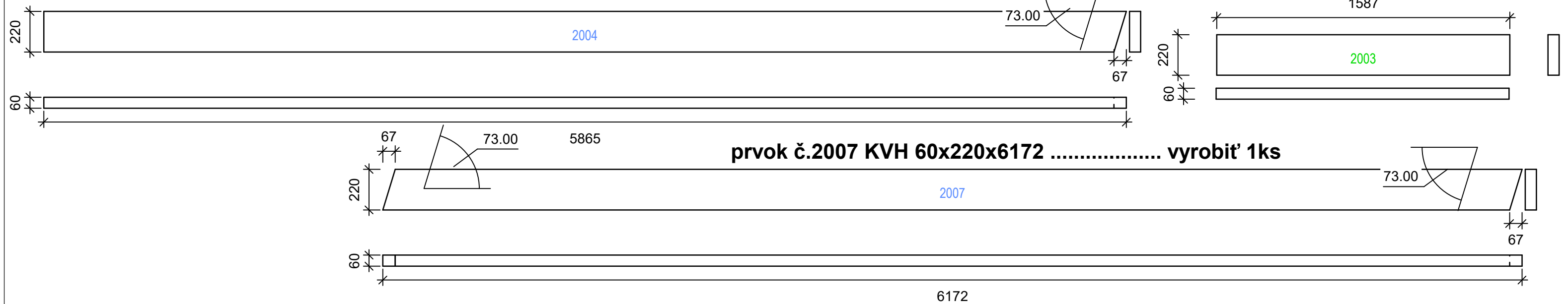

prvok č.2007 KVH 60x220x6172 vyrobiť 1ks

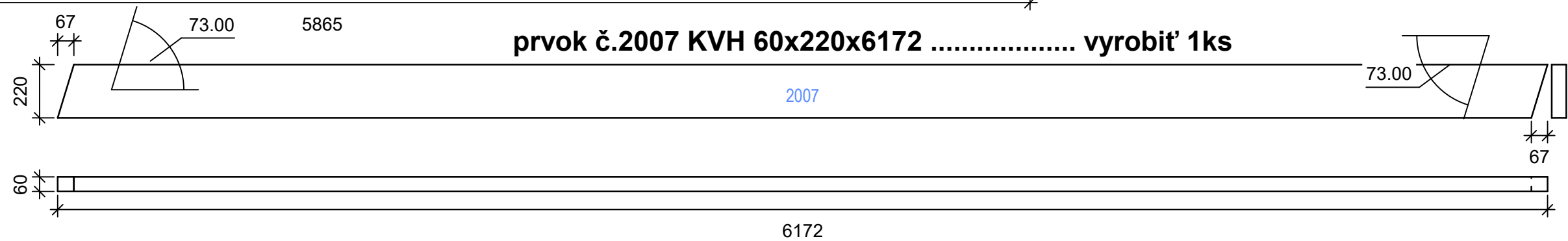

prvok č.2008 KVH 60x120x7410 vyrobiť 1ks

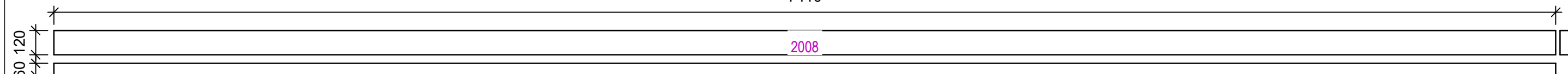

prvok č.2009 KVH 60x120x5328 vyrobiť 1ks

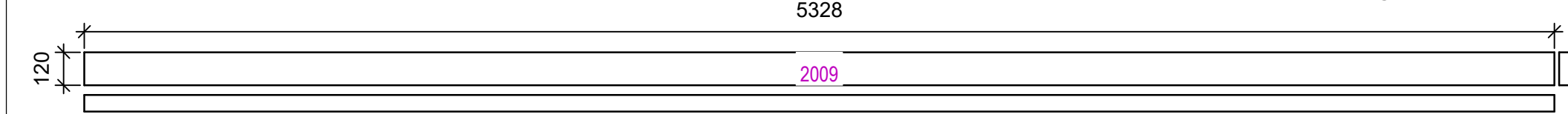

prvok č.2010 KVH 60x220x6207..... vyrobiť 6ks

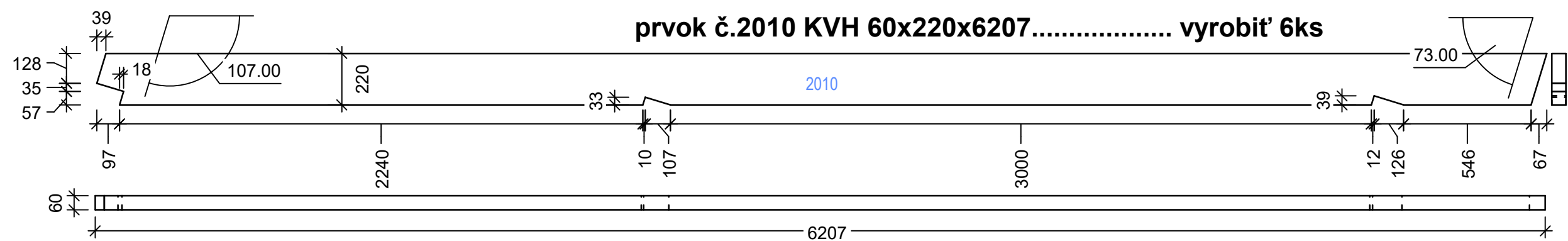

2 prvky KVH 60x220x6144 vyrobiť 1 zostavu

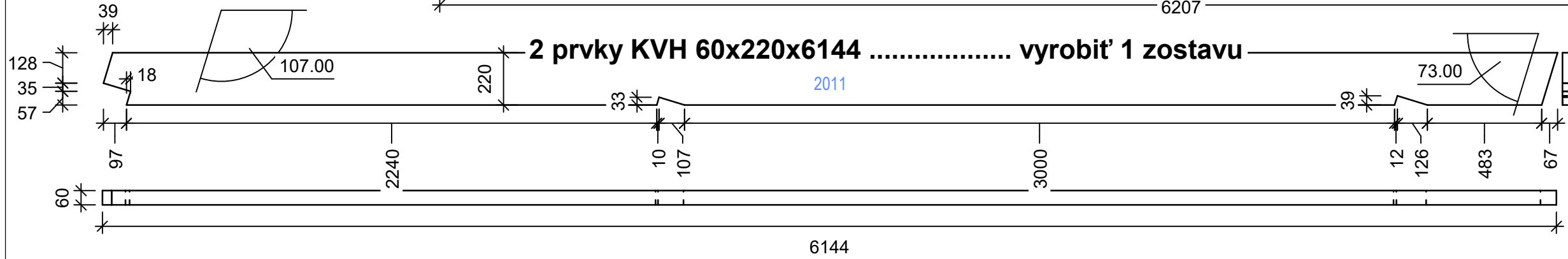

A	06-10-2017		CM
indice	date	modifications	nom

Projet: RD Zábojníkovci	Carnet: 06-210 (plancad n° 210)	Echelle: 1/10°
Nom du plan: prvky II.hlavnej šikmejstrechy		Maitre d'ouvrage:
Chargé d'Affaire:	Dessinateur:	N° d'affaire:



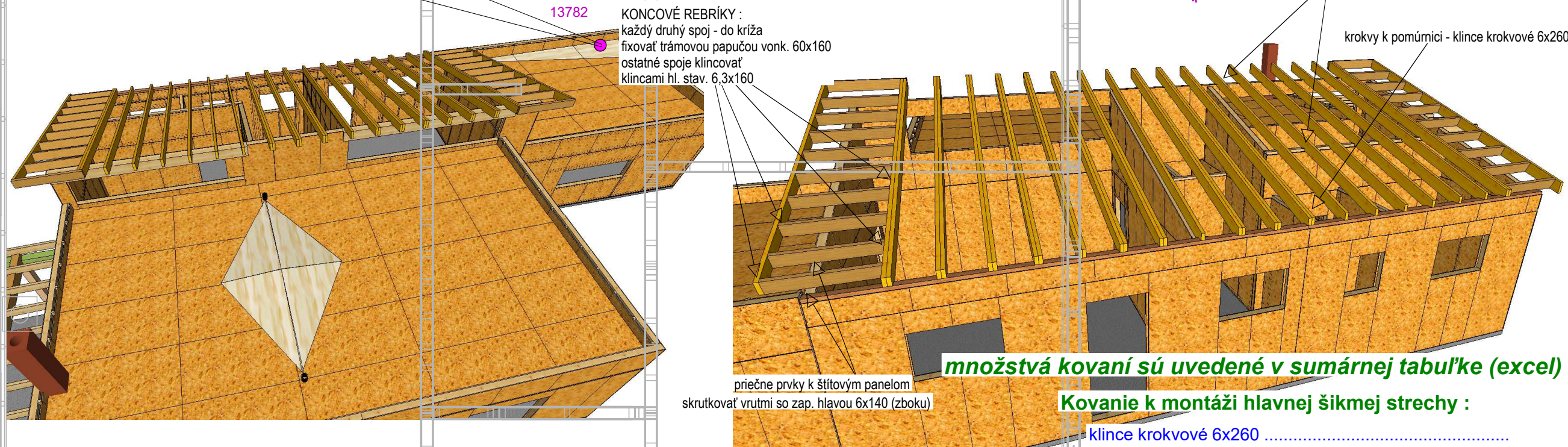
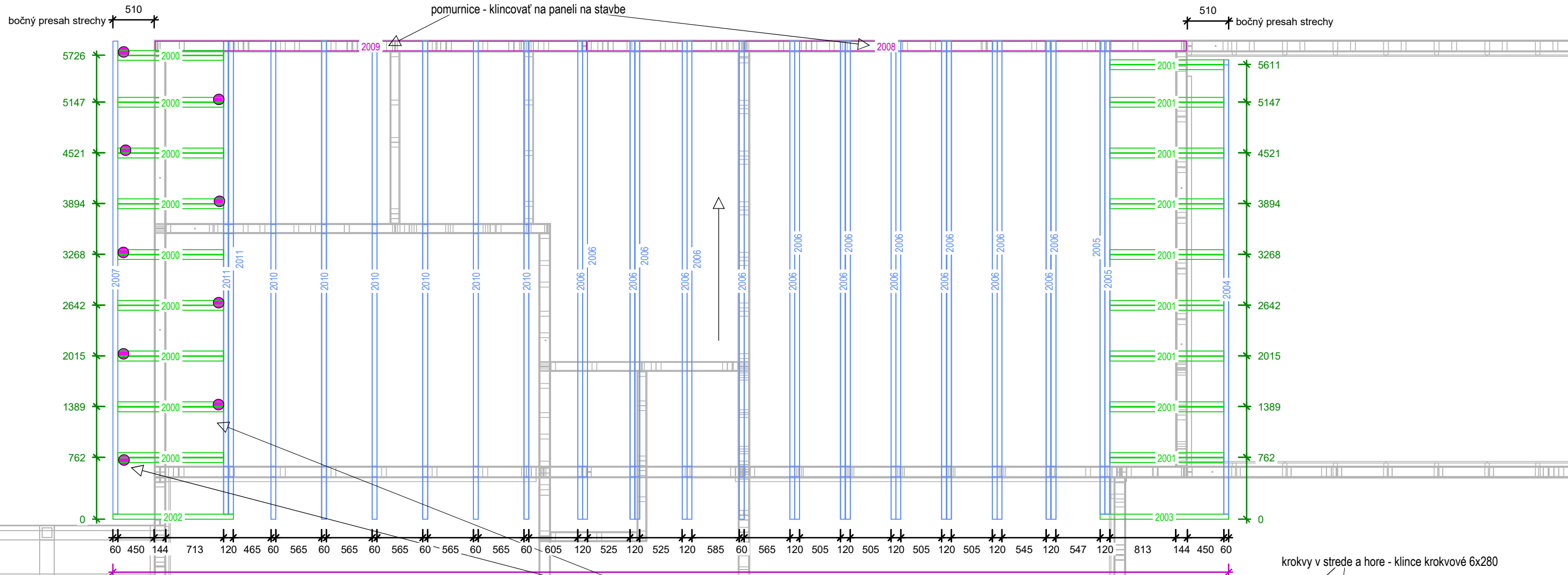

A	13-10-2017		CM
indice	date	modifications	nom

Projet: RD Zábojníkovci	Carnet: 211 (placard n° 211)	Echelle: 1/10°
Maitre d'ouvrage:	Chargé d'Affaire:	N° d'affaire:
Nom du plan: montáž hlavnej strechy		
Dessinateur:		

Predpokladaná skladba hlavnej šikmej strechy :

- * krytina falcový plech
- * strešné laty 40x50
- * štrukturovaná rohož DELTA
- * záklop OSB 22 (pero-drážka)
- * vetracia medzera - kontralaty 60x80
- * strešná difúzna folia - poistná hydroizolácia
- * krokvy - tep. izolácia medzi krokvmi hr.200mm
- * tepelná izolácia pod krokvmi hr.200mm
- * parozábrana
- * sadrokarton protipožiarny 12,5

DO PRÍBALU :

- pásky OSB 12x35028bm
- pásky OSB 12x27014bm
- pásky OSB 12x34014bm
- celý formá OSB 121 ks
- rošty 40x50 70bm
- polystyrén hr.20 + ometka20,7m2 (presne)

Predpokladaná úprava podaší strechy :

- * vyrovnávacie rošty 40x50
- * OSB dosky hr.12mm
- * polystyrén hr.20mm+omietka

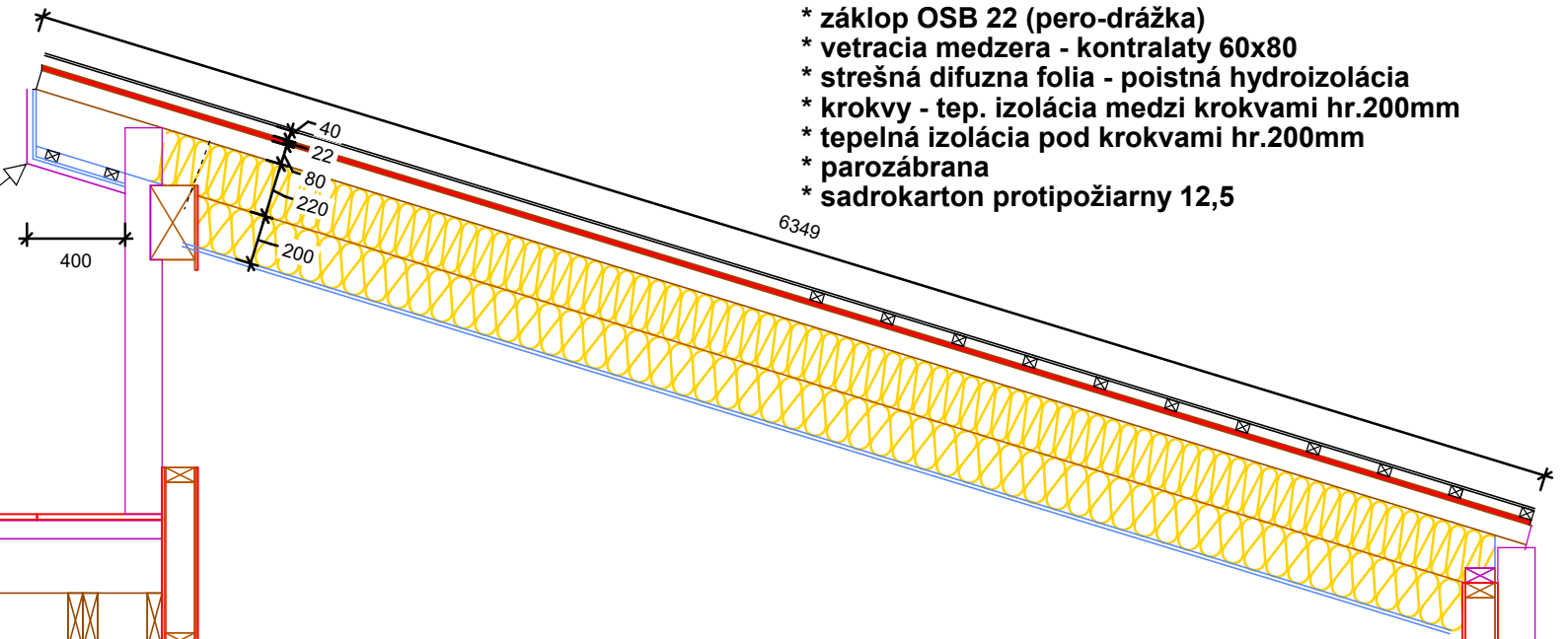

DO PRÍBALU :

- dosky OSB 22x625x2500 (pero-drážka) 95m2
- strešná difúzna folia 105m2
- kontralaty 60x80 150bm
- strešné laty 40x50 300bm
- tepelná izolácia hr.200mm 138 m2 (= 2 vrstvy)
- parozábrana 80m2

- výmera hlavnej strechy 89 m2
- horná strešná hrana 13,8bm
- dolná strešná hrana - okap 13,8bm
- bočné šikmé lemovania 12,4 bm

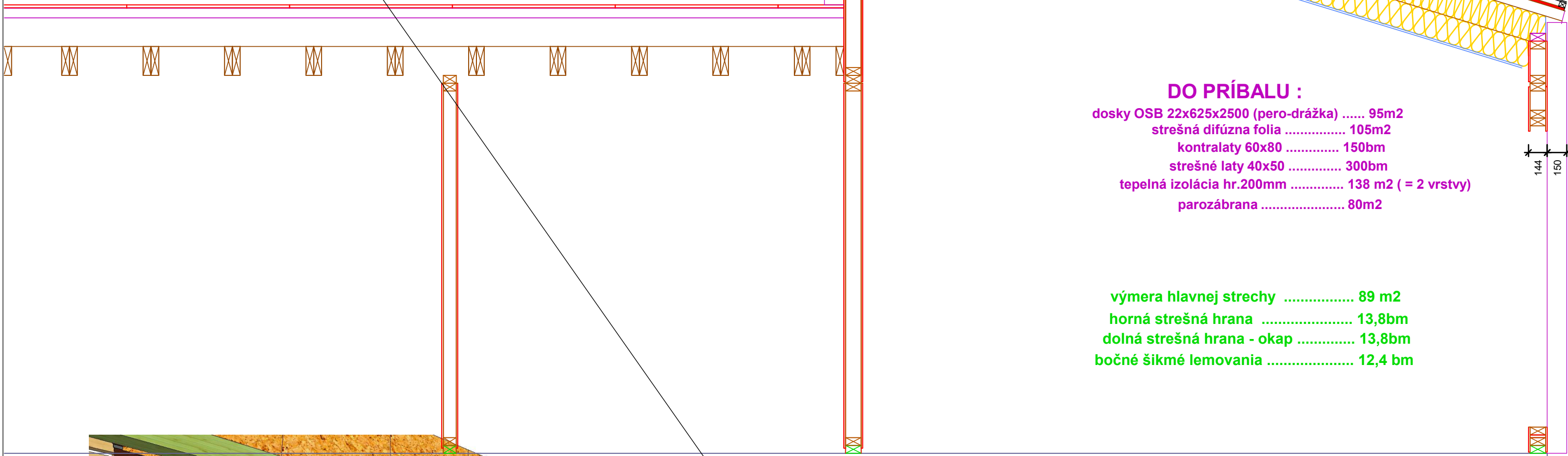

v príbale je uvažované aj ometkovými ukončením stropu nad vchodom



A	13-10-2017	CM
indice	date	modifications
		nom

Projet: RD Zábojníkovci	Carnet: 212 (placád n° 212)	Echelle: 1/10°
Maitre d'ouvrage:	Chargé d'Affaire:	N° d'affaire:
Nom du plan: ukončenie hlavnej strechy		
Dessinateur:		

prvok č.1004 KVH 60x220x7333 vyrobiť 2ks

7333

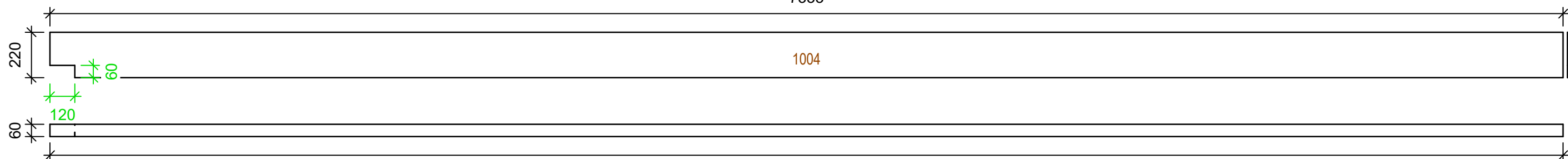

7333

stropné zostavy č.1004..... vyrobiť 9ks zostáv

7333

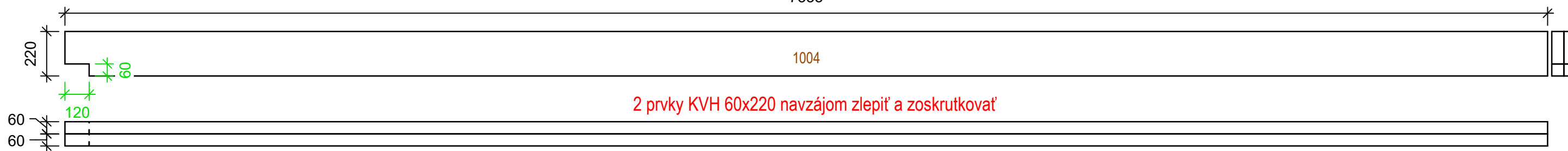

7333

prvok č.1010 KVH 60x220x565..... vyrobiť 1ks

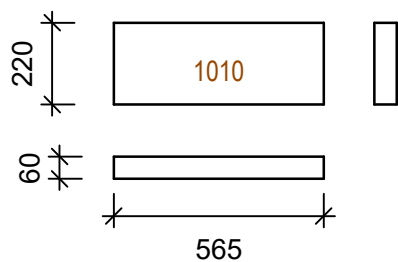

stropná zostava č.1004+1005..... vyrobiť 1 zostavu

2 prvky KVH 60x220 navzájom zlepiť a zoskrutkovať

1004 1005

220

7241

132
60
60

1004 1005

7333

7241

1005

110

200

40

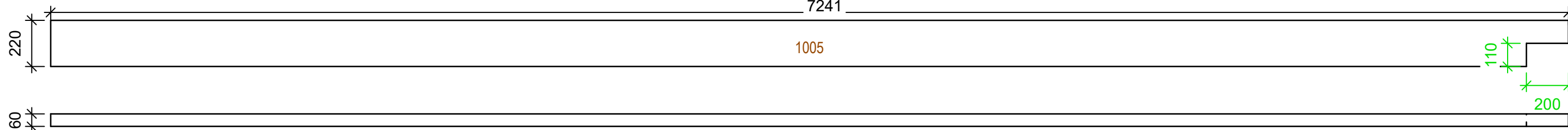

A	10-10-2017		CM
indice	date	modifications	nom

Projet: RD Zábojníkovci	Carnet: 06-216 (plancad n° 216)	Echelle: 1/10°
Nom du plan: prvky I. hlavnej atik strechy		Maitre d'ouvrage:
Chargé d'Affaire:	Dessinateur:	N° d'affaire:

stropné zostavy č.1026..... vyrobiť 10ks zostáv

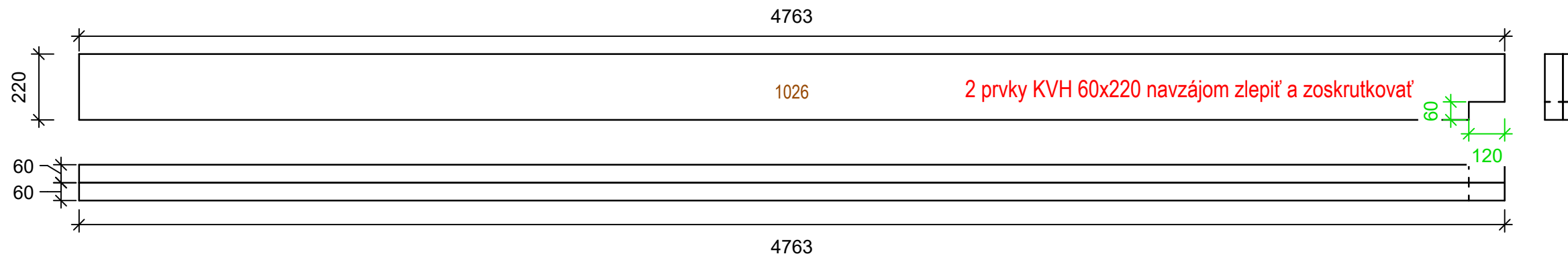

prvok č.1070 KVH 60x220x4671..... vyrobiť 1ks

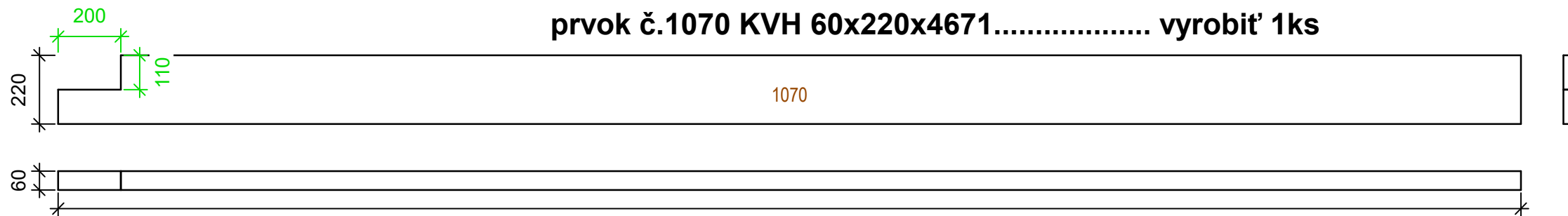

prvok č.1006 KVH 60x220x1540..... vyrobiť 1ks

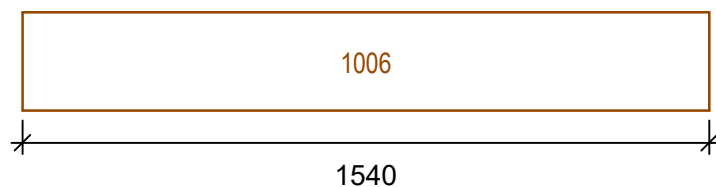

prvok č.1008 KVH 60x220x4345..... vyrobiť 1ks

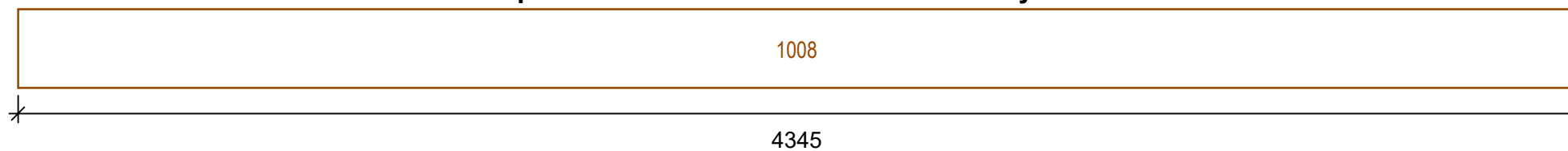

spádový klin pravý KVH 60x160x4770..... vyrobiť 12ks

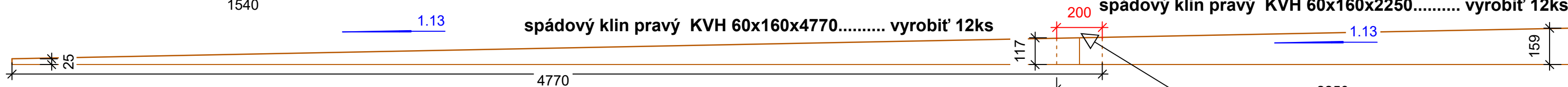

spádový klin pravý KVH 60x160x2250..... vyrobiť 12ks

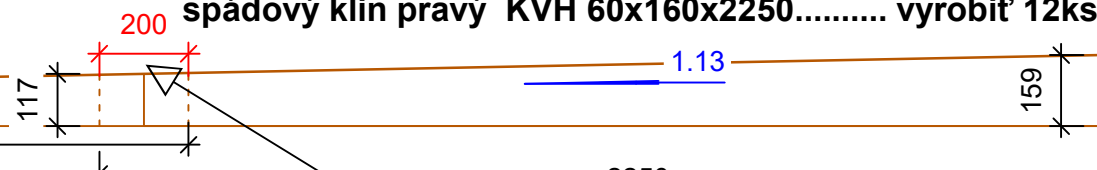

spádový klin ľavý KVH 60x160x4740..... vyrobiť 12ks

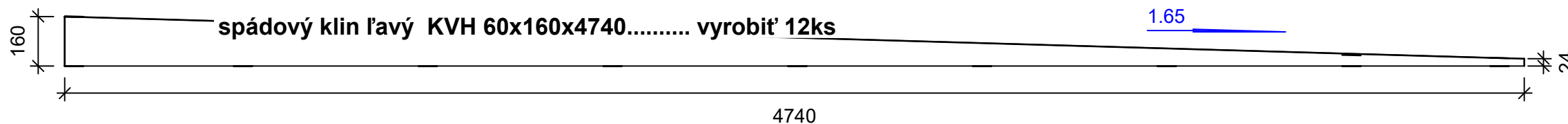

založenie-prienik na stavbe 20cm (dať montérom)

prvok č.1011 KVH 60x220x6450..... vyrobiť 21ks

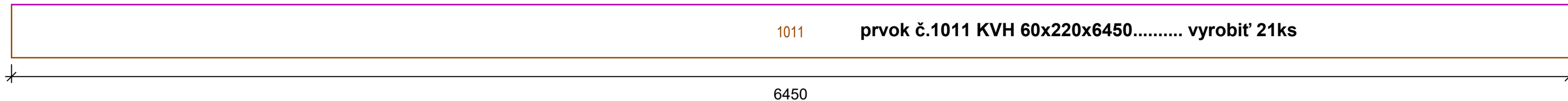

A	21-11-2017		CM
indice	date	modifications	nom

Projet: RD Zábojníkovci	Carnet: 06-217 (plancad n° 217)	Echelle: 1/10°
Nom du plan: prvky II.hlavnej atik strechy		Maitre d'ouvrage:
Chargé d'Affaire:	Dessinateur:	

prvok č.1062 KVH 60x104x1315..... vyrobiť 1ks

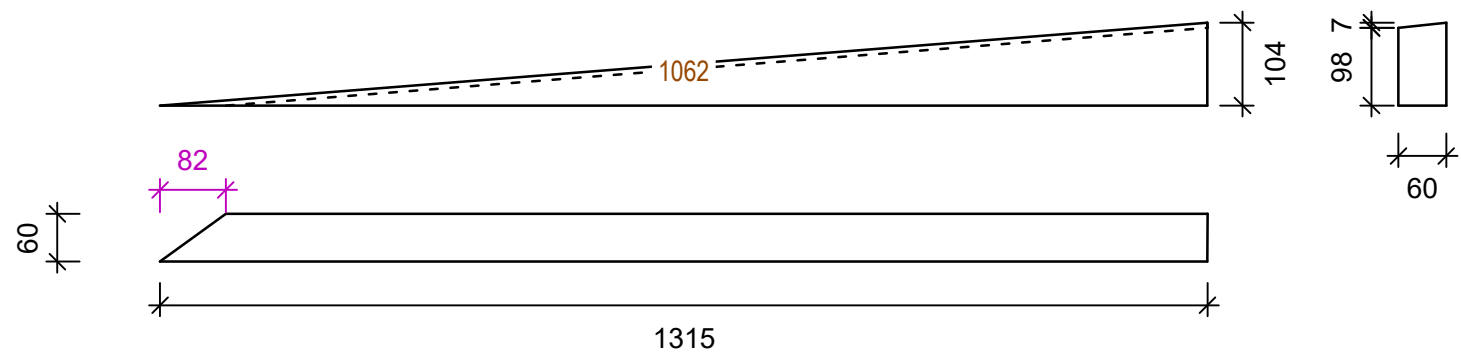

prvok č.1063 KVH 60x104x1311..... vyrobiť 1ks

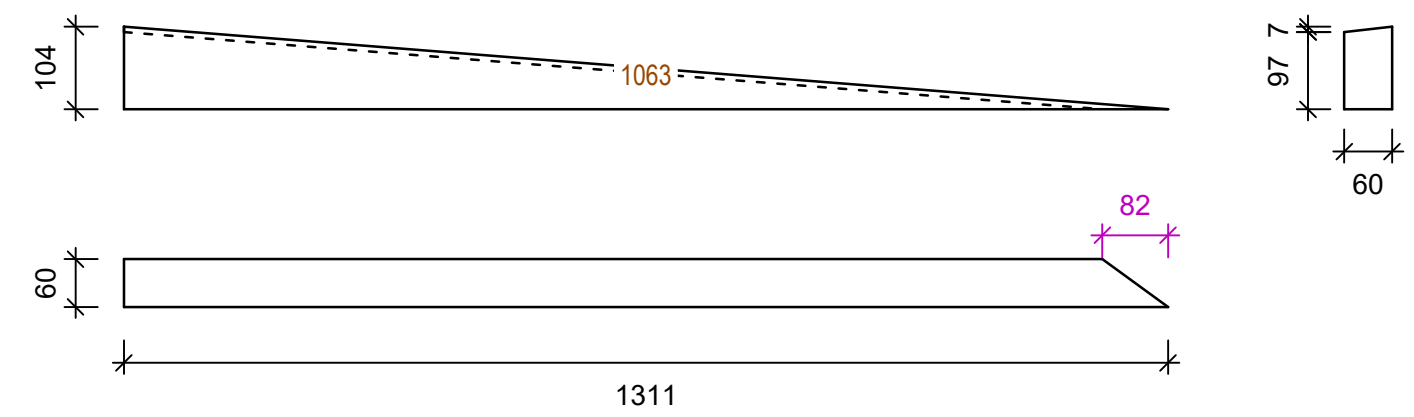

prvok č.1064 KVH 60x157x1975..... vyrobiť 1ks

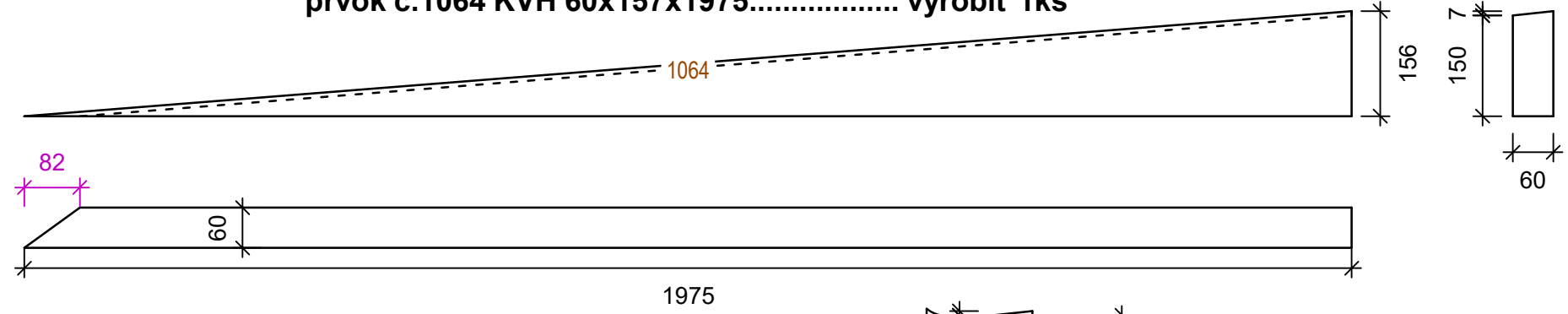

prvok č.1065 KVH 60x156x1972..... vyrobiť 1ks

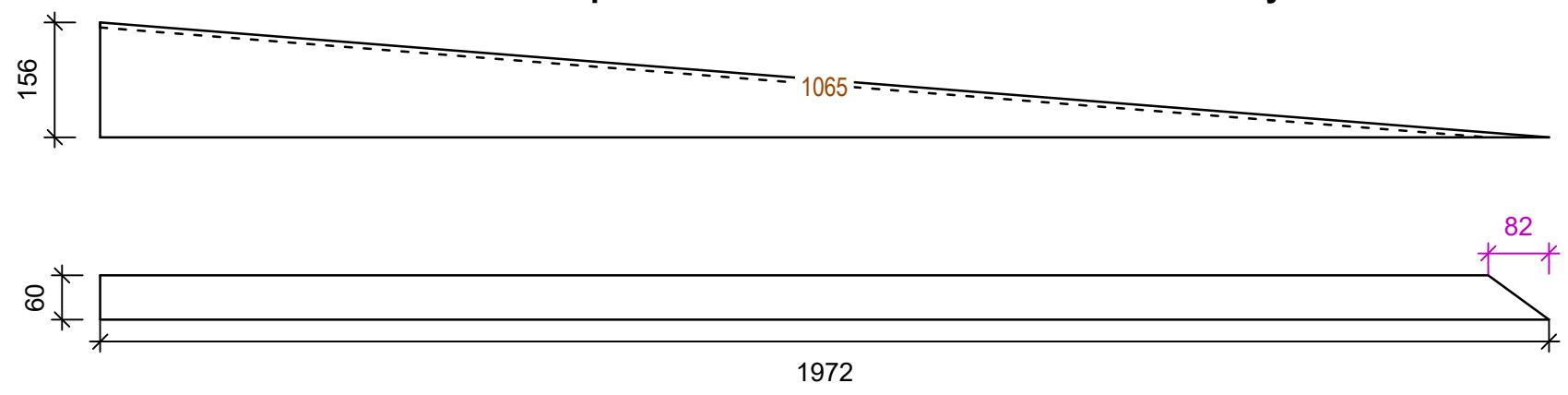

prvok č.1066 KVH 60x158x2006..... vyrobiť 1ks

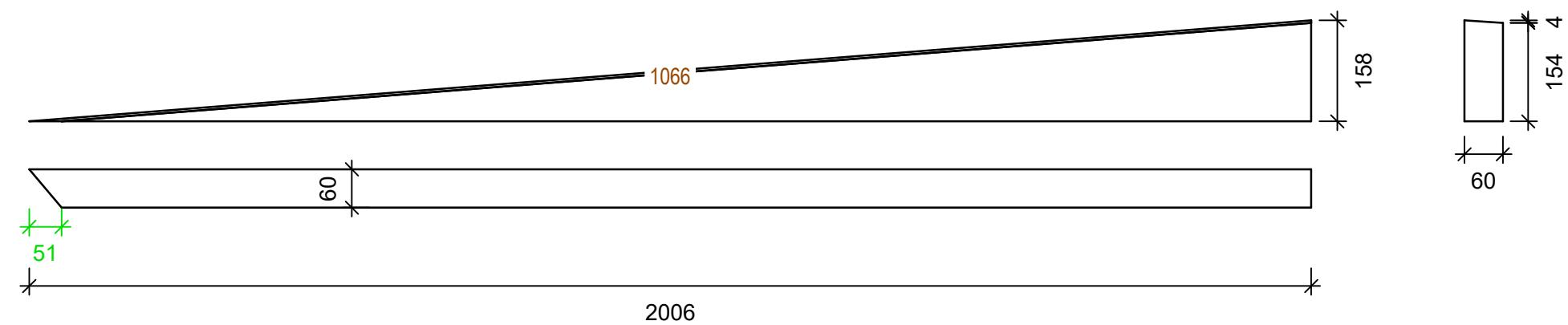

A	08-10-2017		CM
indice	date	modifications	nom

Projet: RD Zábojníkovci		Carnet: 06-221 (plancad n° 221)	Echelle: 1/10°
Nom du plan: prvky VI.hlavnej atik strechy		Maitre d'ouvrage:	
Chargé d'Affaire:		Dessinateur:	N° d'affaire:



prvok č.1067 KVH 60x158x2004..... vyrobiť 1ks

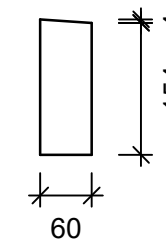
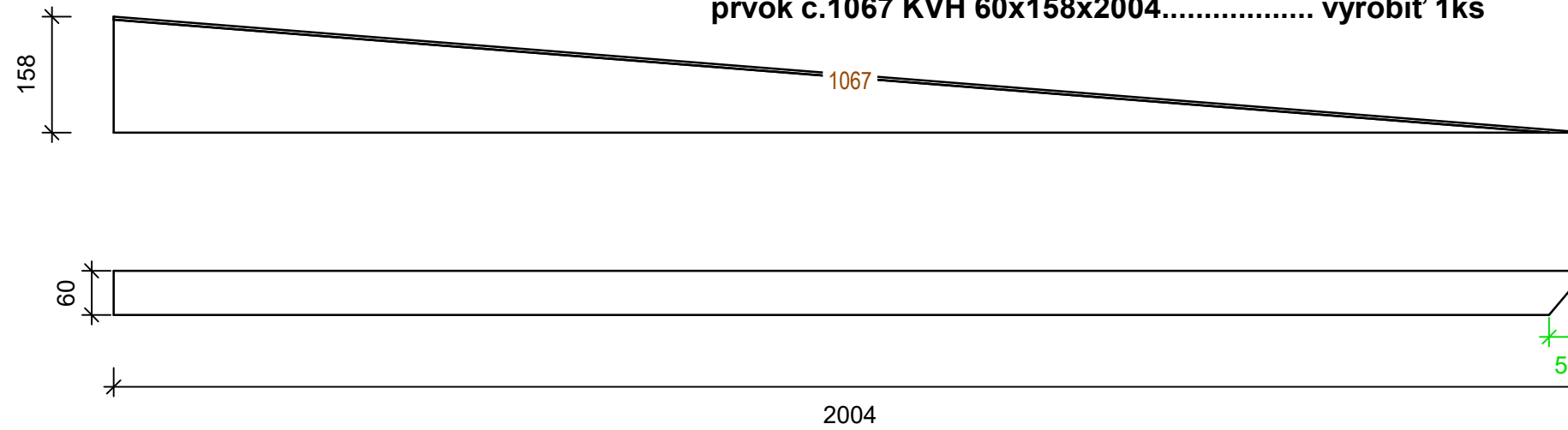

prvok č.1068 KVH 60x120x1518..... vyrobiť 1ks

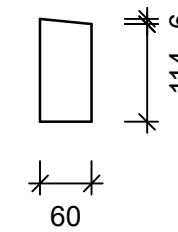
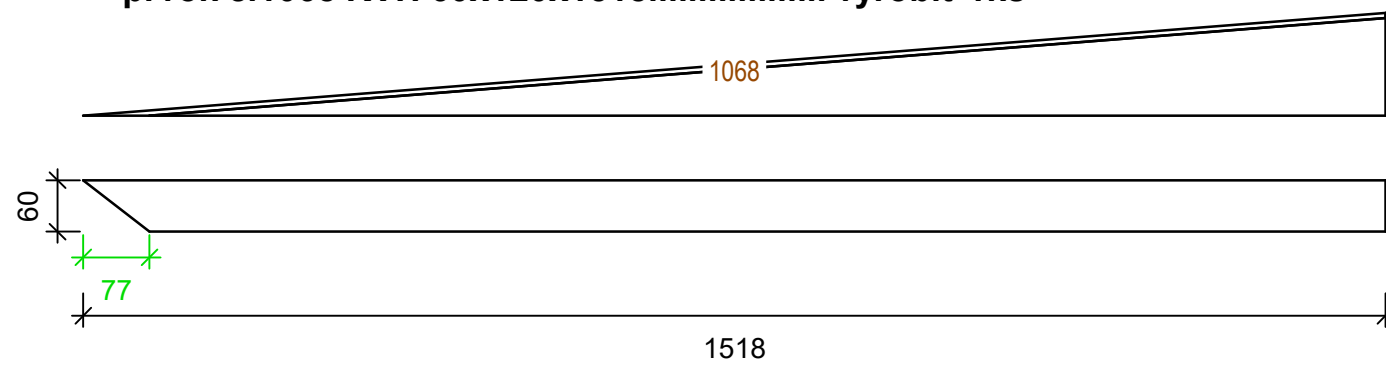

prvok č.1069 KVH 60x120x1518..... vyrobiť 1ks

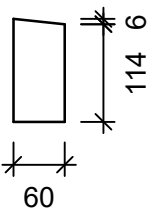
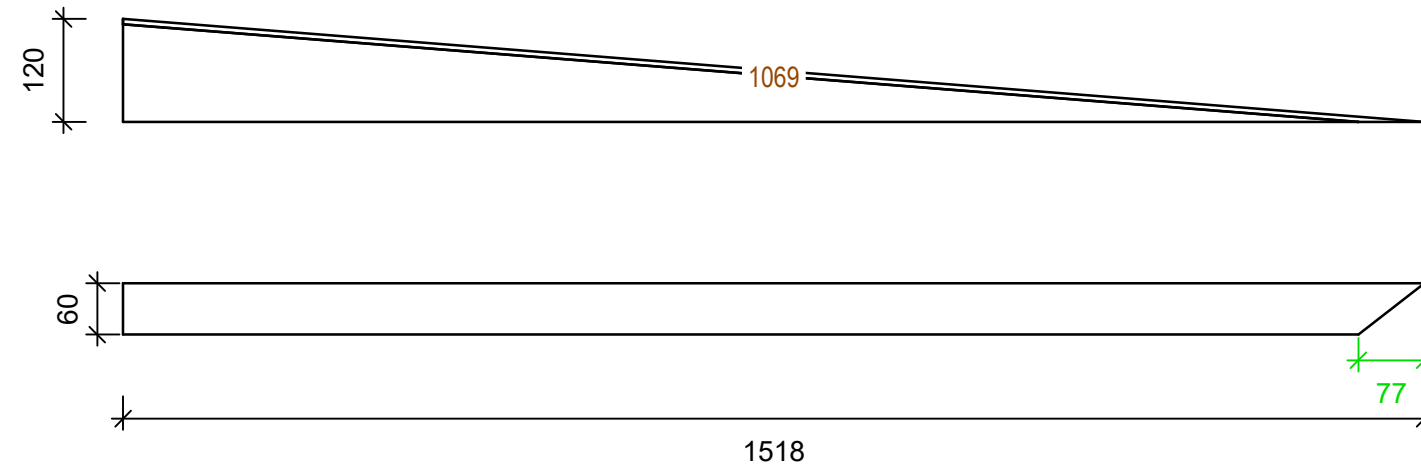

DO PRÍBALU :

dosky OSB 22x625x2500 (pero-drážka) 94m²

indice	date	modifications	nom
A	08-10-2017		CM

Projet: RD Zábojníkovci	Carnet: 06-226 (plancad n° 226)	Echelle: 1/10°
Nom du plan: prvky VII.hlavnej atik strechy	Maitre d'ouvrage:	
Chargé d'Affaire:	Dessinateur:	

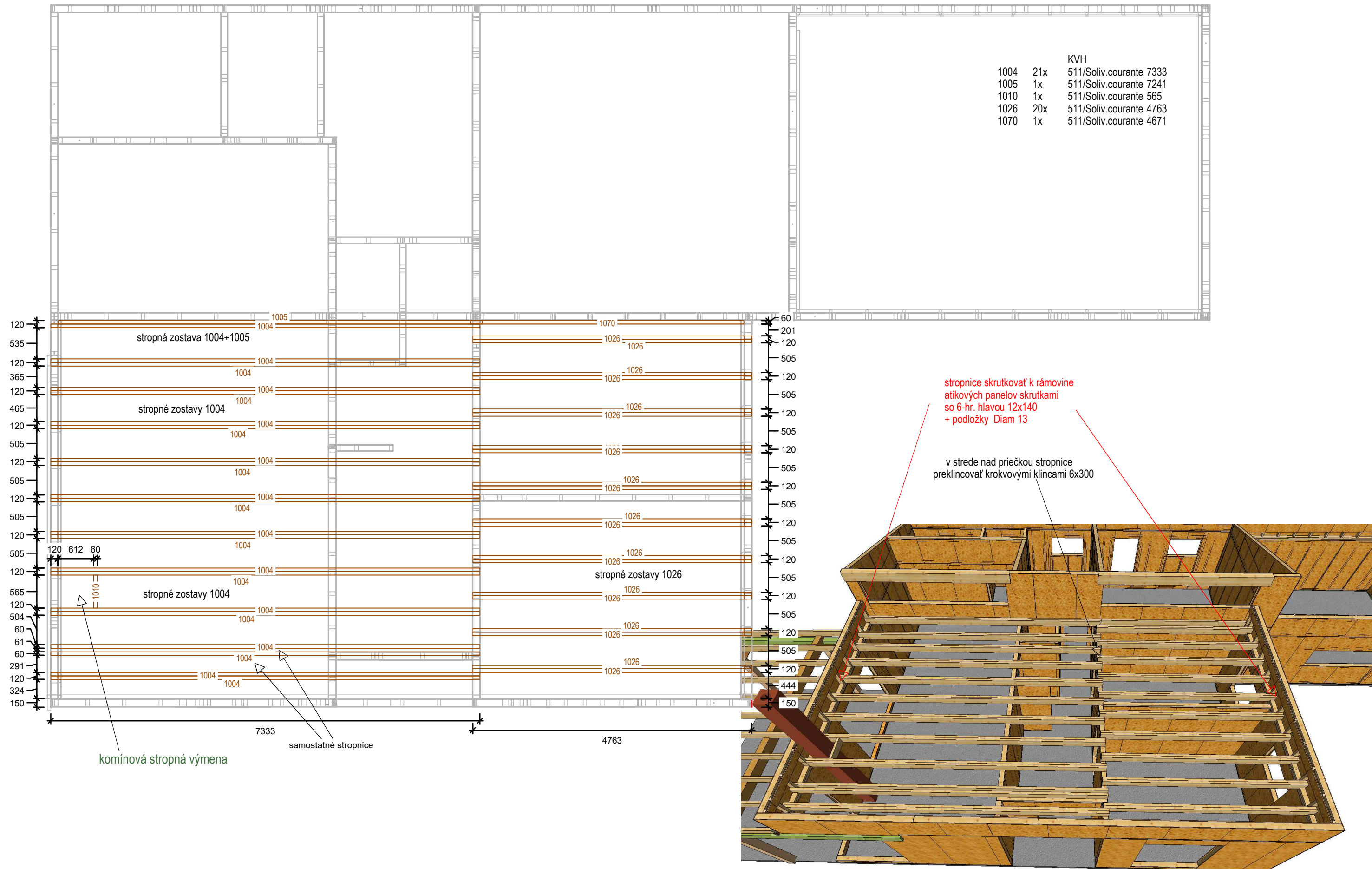

		KVH
1004	21x	511/Soliv.courante 7333
1005	1x	511/Soliv.courante 7241
1010	1x	511/Soliv.courante 565
1026	20x	511/Soliv.courante 4763
1070	1x	511/Soliv.courante 4671

komínová stropná výmena

samostatné stropnice

stropnice skrutkovať k rámovine atikových panelov skrutkami so 6-hr. hlavou 12x140 + podložky Diam 13

v strede nad priečkou stropnice preklincovať krokrovými klincami 6x300

indice	date	modifications	nom
A	13-10-2017		CM

Projet: RD Zábojníkovci	Carnet: 250 (placard n° 250)	Echelle: 1/10°
Maitre d'ouvrage:	Chargé d'Affaire:	N° d'affaire:
Nom du plan: montáž hlavnej atik strechy I.		
Dessinateur:		

KONTRA - STROPNICE KVH 60x220 + SPÁDOVÉ KLINY STRECHY

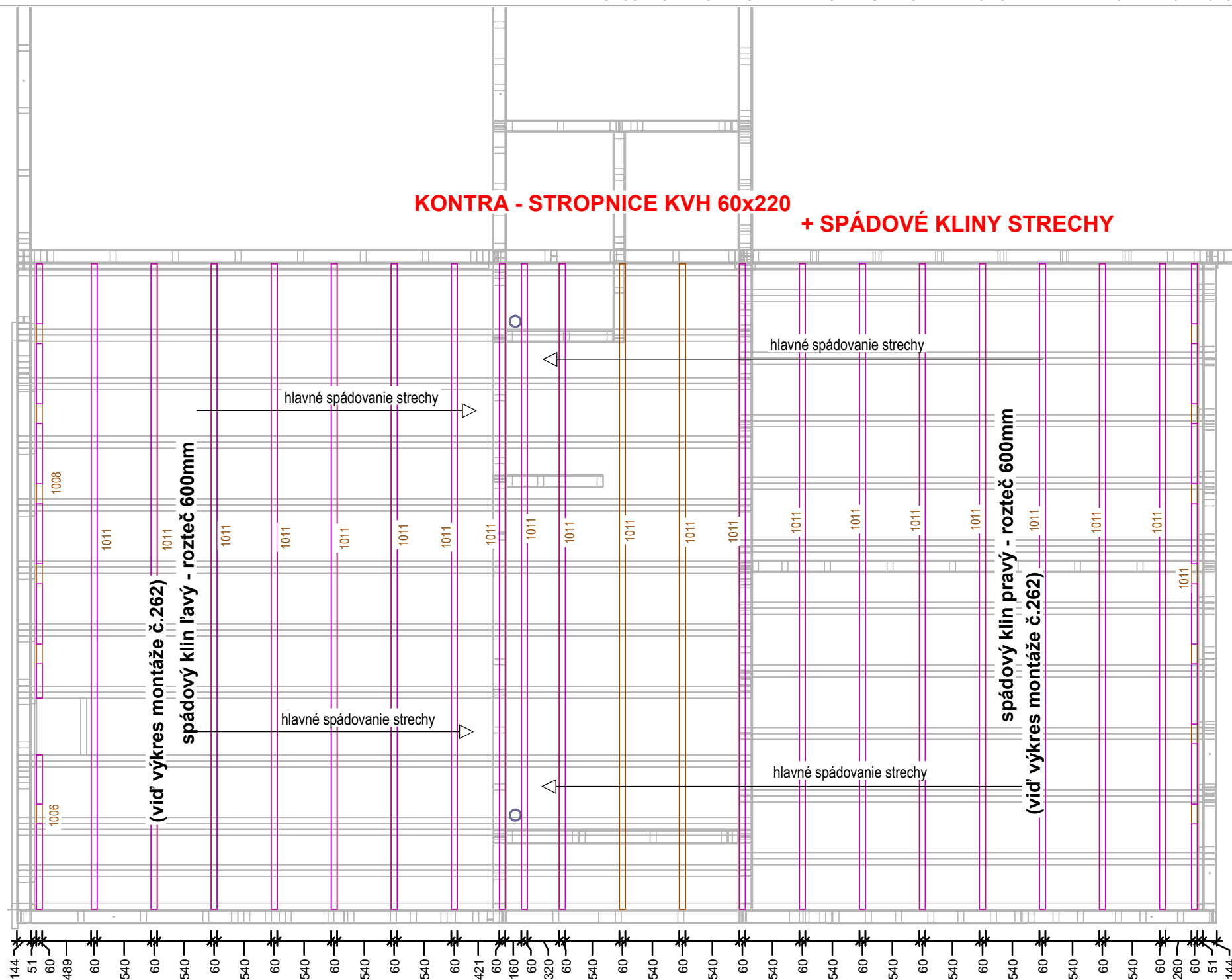

každú kontra-stropnicu klincovať k nosným stropniciam min. na každom treťom podpernom bode klincami krokovými 6x300 + skrutkami so zap. hlavou - podľa potreby a uváženia

spádový klin ľavý + pravý :
skrutkovať k stropniciam skrutkami so zap. hlavou (dĺžky v rozmedzí 100-200mm)

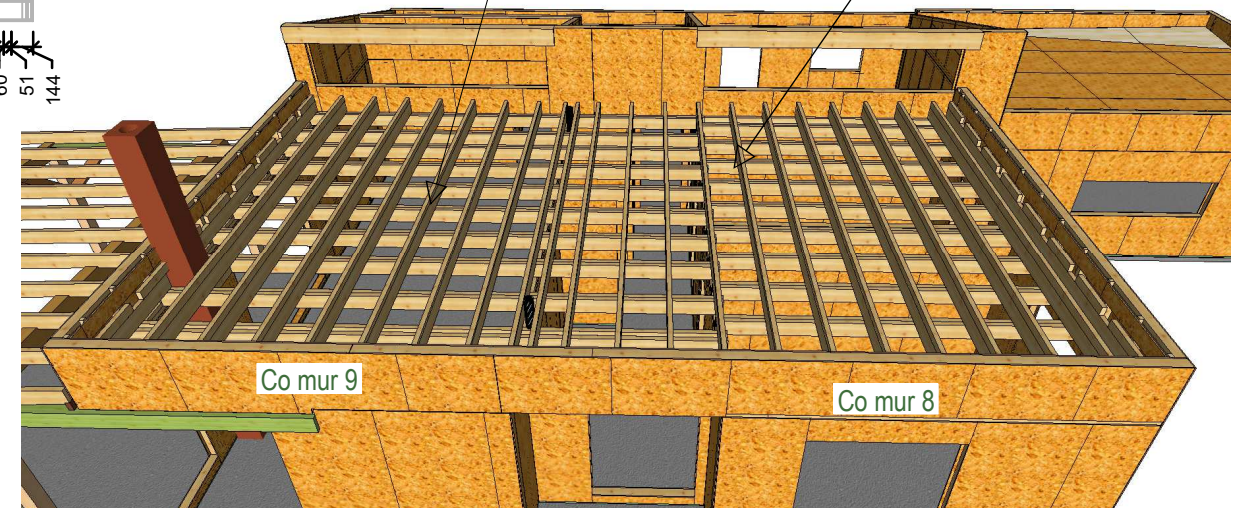

A	13-10-2017		CM
indice	date	modifications	nom

Projet: RD Zábojníkovci	Carnet: 255 (placard n° 255)	Echelle: 1/10°
Maitre d'ouvrage:	Chargé d'Affaire:	N° d'affaire:
Nom du plan: montáž hlavnej atik strechyll.		
Dessinateur:		

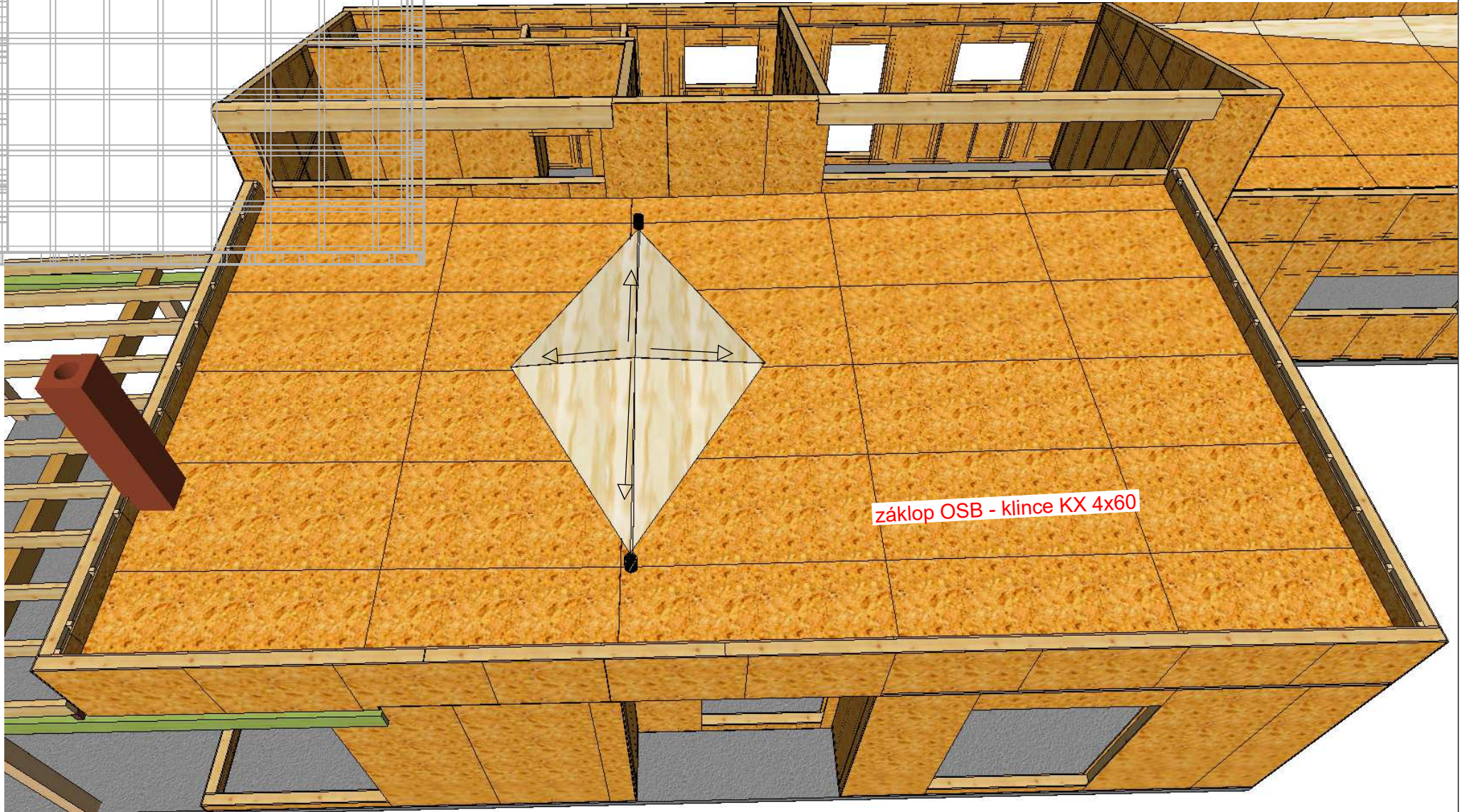
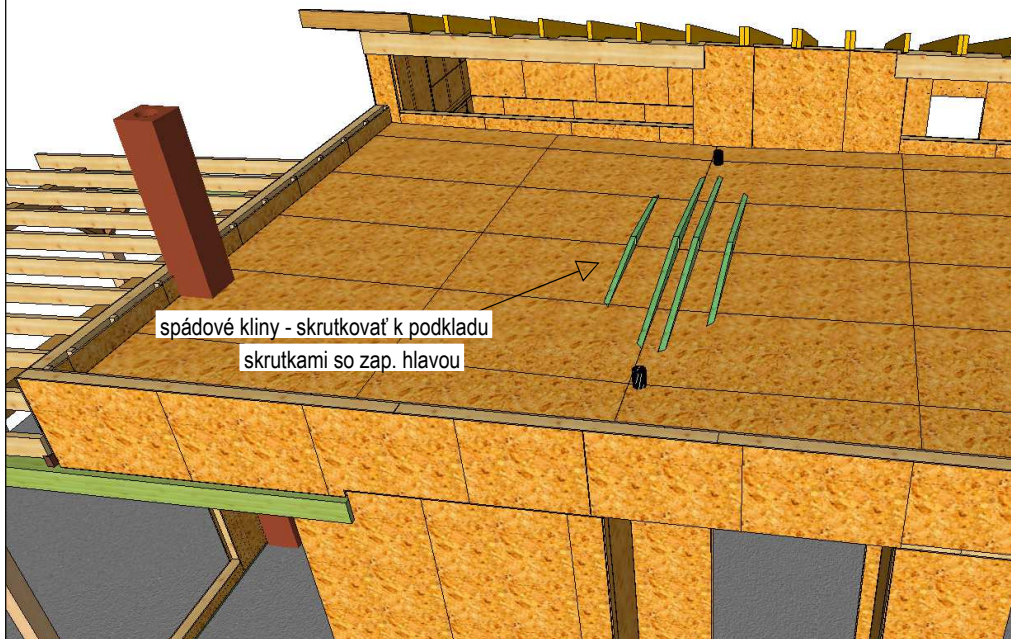
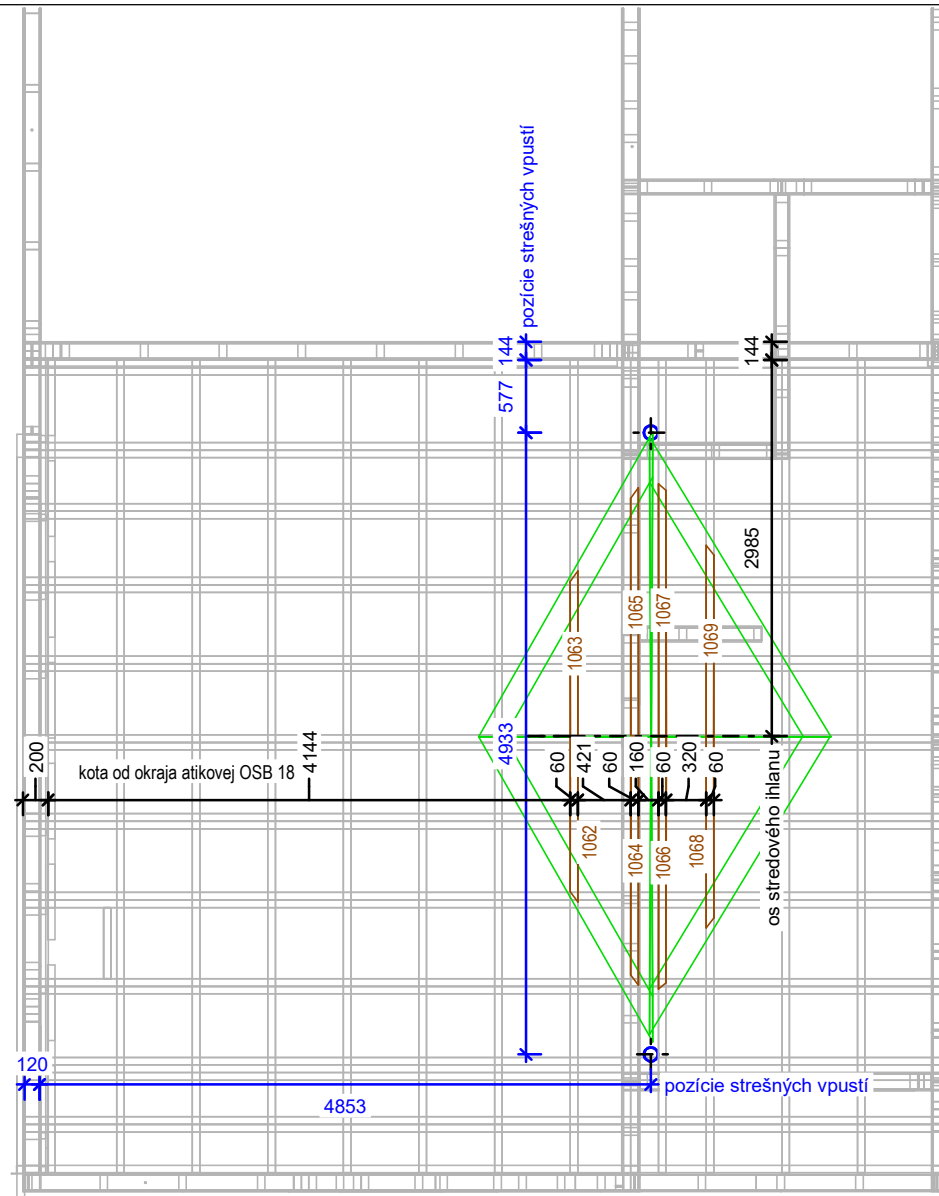

A	11-10-2017		CM
indice	date	modifications	nom

Projet: RD Zábojníkovci	Carnet: 260 (placád n° 260)	Echelle: 1/10°
Maitre d'ouvrage:	Chargé d'Affaire:	N° d'affaire:
Nom du plan: montáž hlavnej atik strechyIII		
Dessinateur:		

Predpokladaná skladba garážovej strechy :

- * krytina Fatrafol
- * záklop OSB 22 (pero-drážka)
- * vetracie roštovanie
- * 1. vrstva-tepelná izolácia hr.200mm
- * 2. vrstva tepelná izolácia hr.200mm
- * parozábrana
- * inštal. medzera
- * sadrokarton protipožiarny 12,5

množstvá kovaní sú uvedené v sumárnej tabuľke (excel)

Kovanie k montáži hlavnej atikovej strechy :

- skrutky so zap. hlavou, dl. 100 - 200mm
- klince krokrové 6x300
- skrutky so 6-hr. hlavou 12x140 + podložky D13
- záklop OSB - klince KX 4x60

dôležité zaizolovať so stropom aj časť atikových panelov

POZOR - záklop strechy OSB22 rezať zarovno doskou OSB18 na atikových panelov

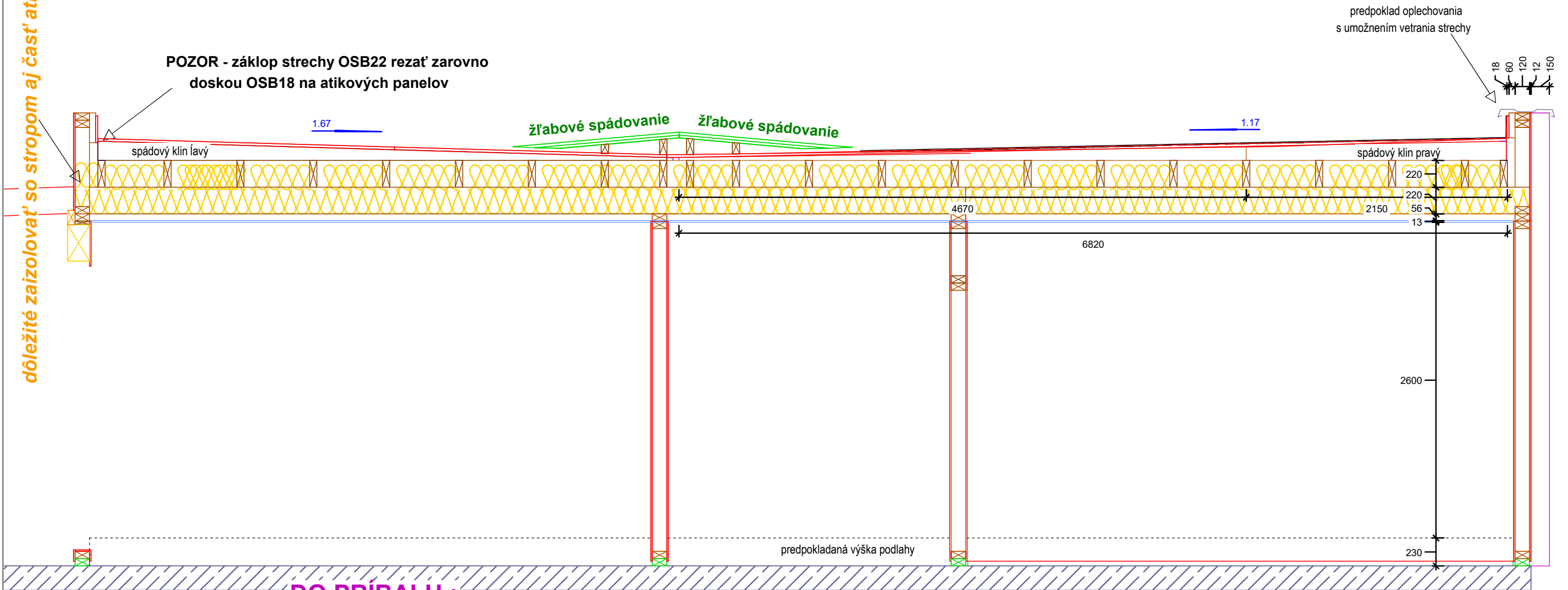

DO PRÍBALU :

- dosky OSB 22x625x2500 (pero-drážka) 90m2
- krytina FATRAFOL - čistá výmera 89 m2
- bežné metre atiky 24,6 bm
- tepelná izolácia hr.200mm144m2 (2 vrstvy izolácie)
- parozábrana 95m2

A	21-11-2017		CM
indice	date	modifications	nom

Projet: RD Zábojníkovci	Carnet: 262 (plancad n° 262)	Echelle: 1/10°
Maitre d'ouvrage:	Chargé d'Affaire:	N° d'affaire:
Nom du plan: hlavná atiková strecha		
Dessinateur:		

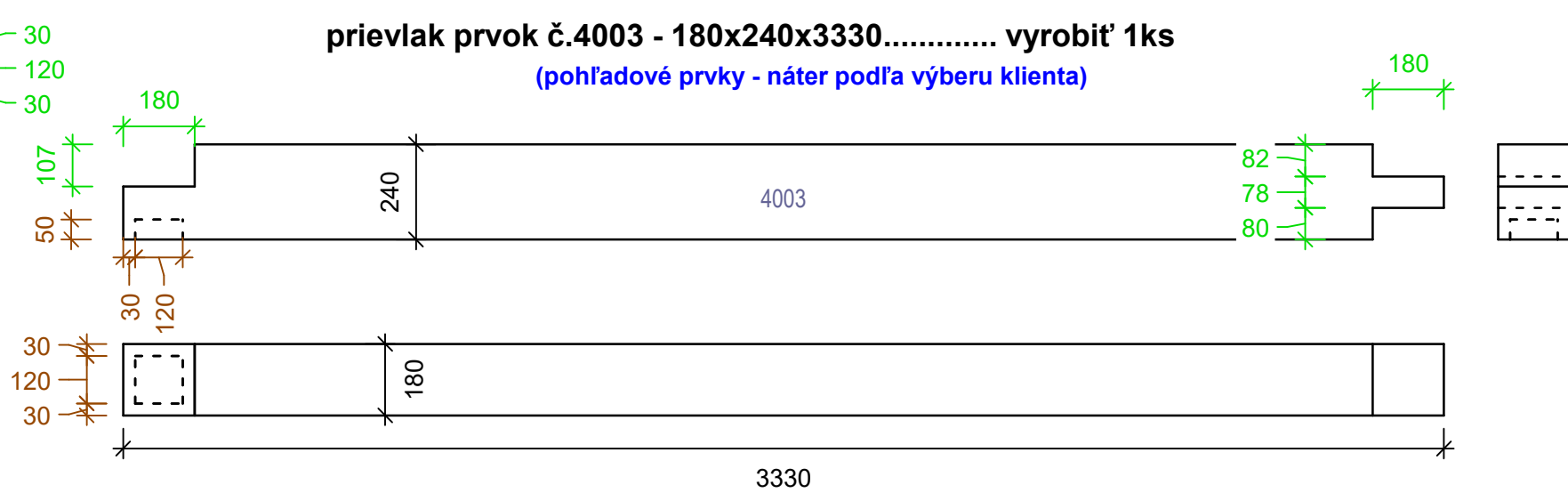
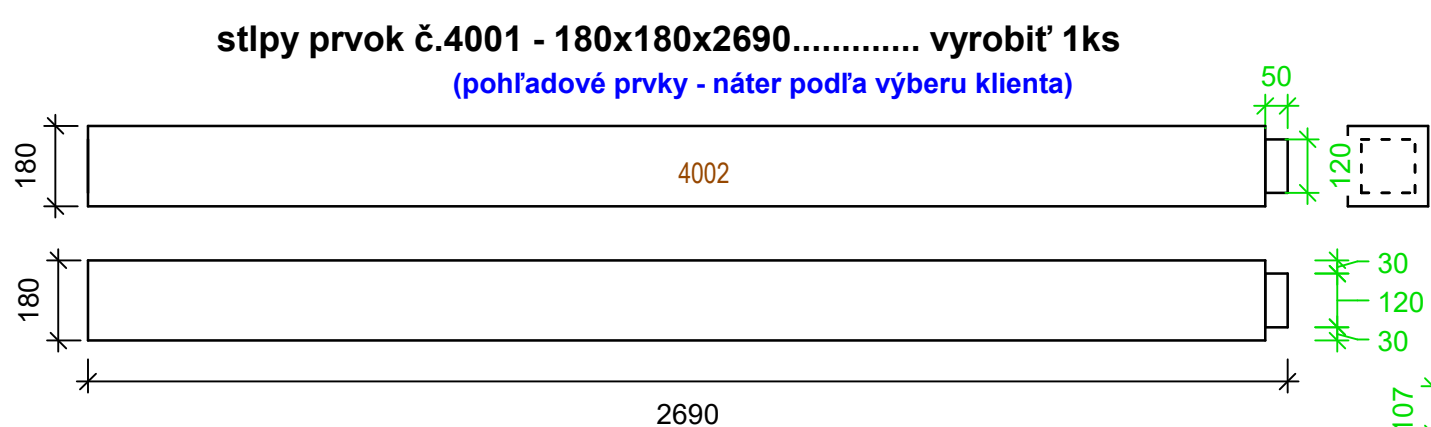
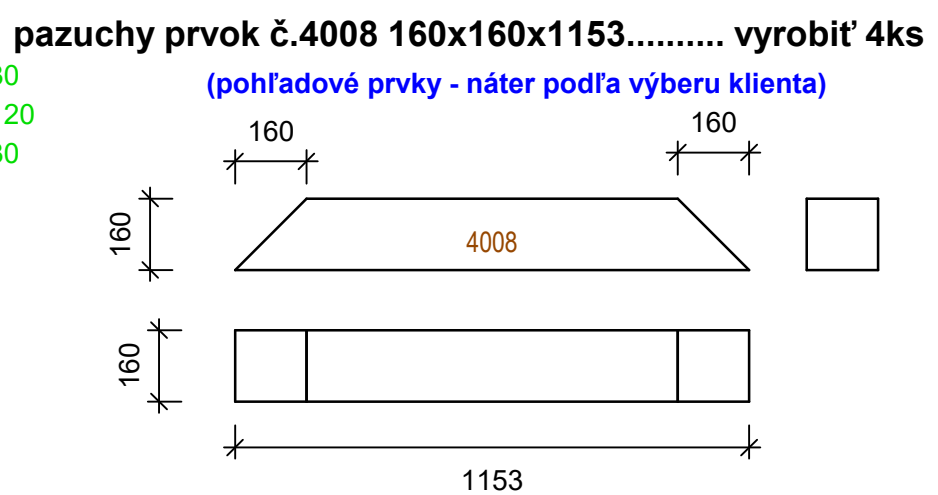
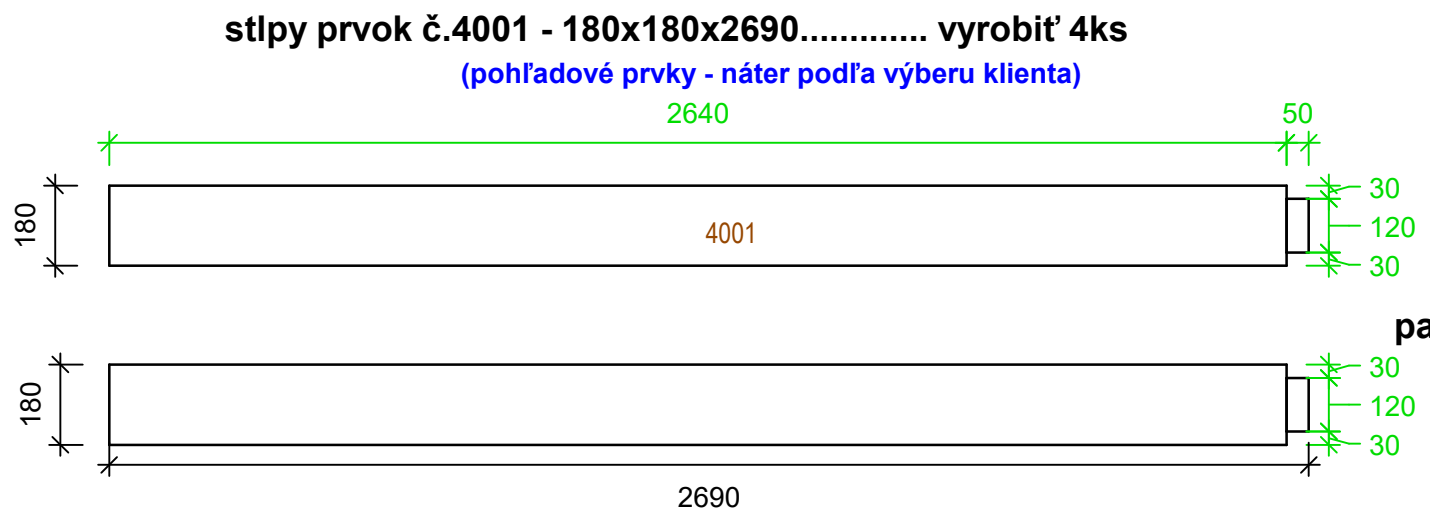
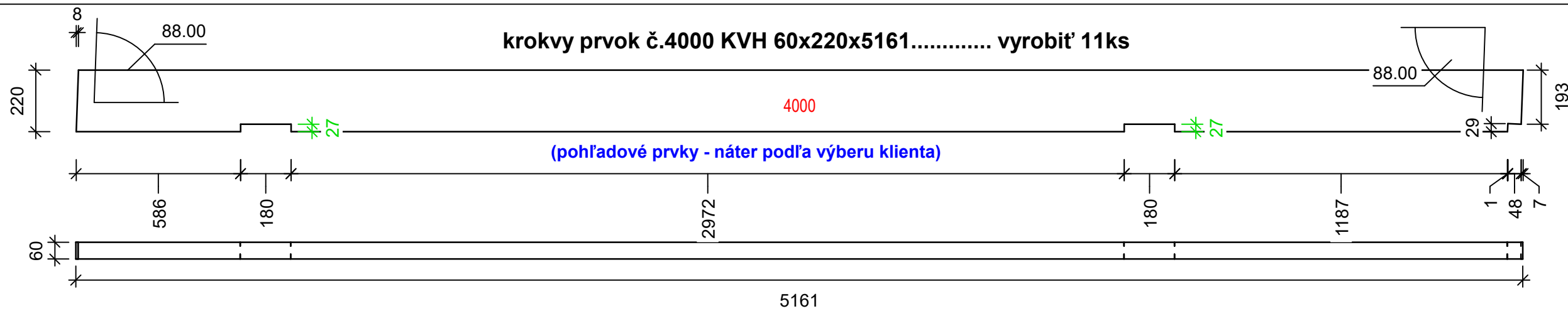

A	16-10-2017		CM
indice	date	modifications	nom

Projet: RD Zábojníkovci	Carnet: 06-300 (plancad n° 300)	Echelle: 1/10°
Nom du plan: prvky prístrešku I.		Maitre d'ouvrage:
Chargé d'Affaire:	Dessinateur:	

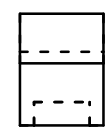
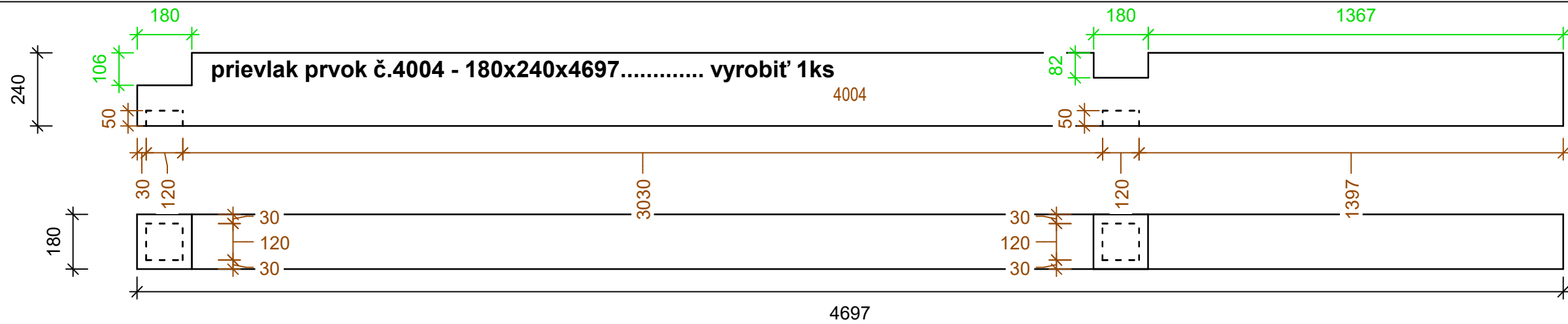

2.00

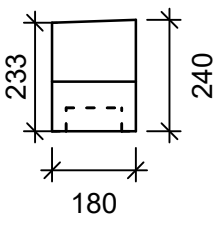
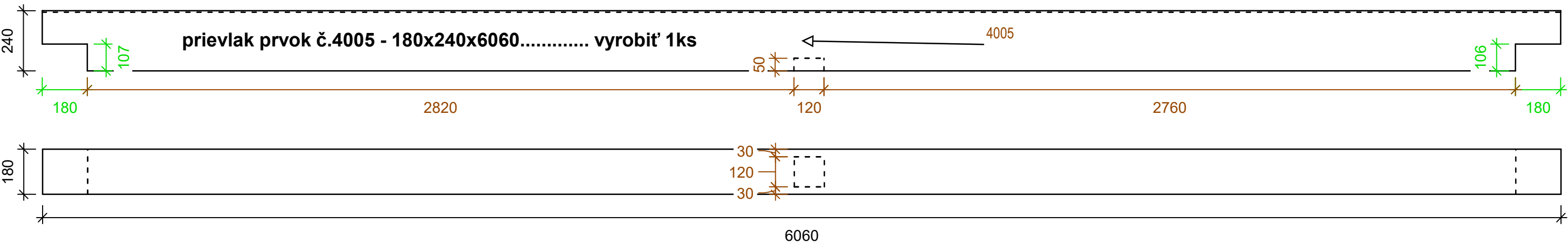

2.00

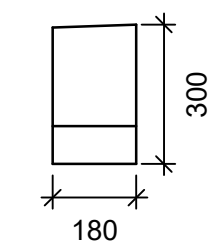
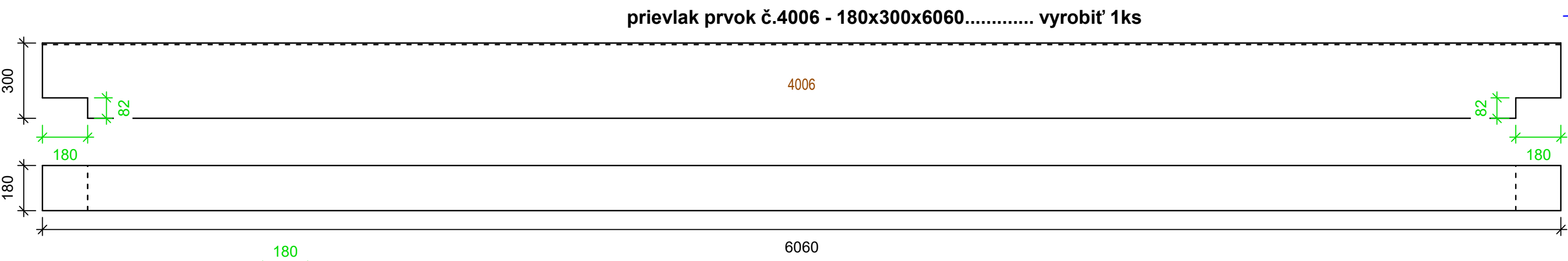

2.00

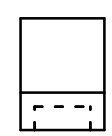
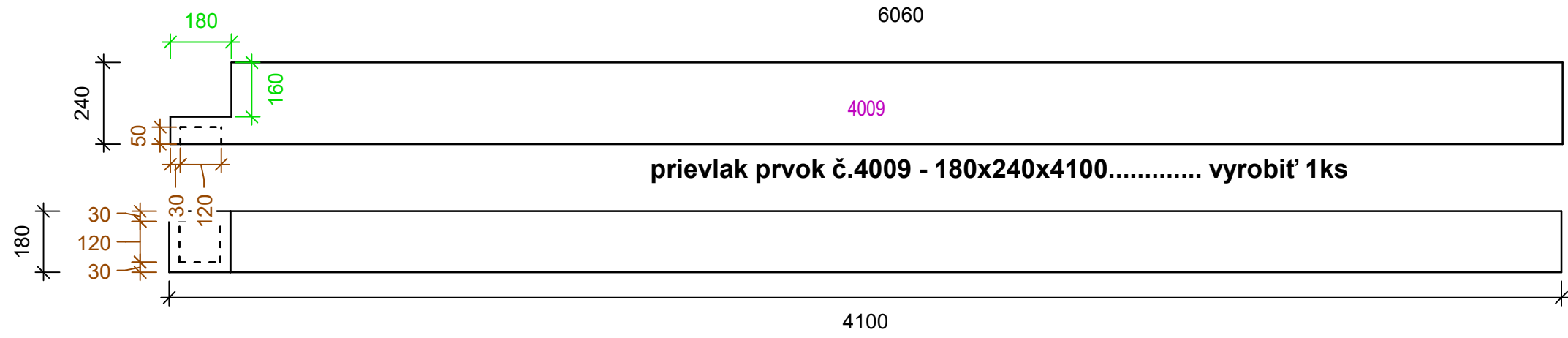

A	09-10-2017		CM
indice	date	modifications	nom

<u>Projet:</u> RD Zábojníkovci	<u>Carnet:</u> 06-304 (plancad n° 304)	<u>Echelle:</u> 1/10°
<u>Nom du plan:</u> prvky prístrešku II.		<u>Maitre d'ouvrage:</u>
<u>Chargé d'Affaire:</u>	<u>Dessinateur:</u>	<u>N° d'affaire:</u>



množstvá kovaní sú uvedené v sumárnej tabuľke (excel)

Kovanie k montáži prístrešku :

- skrutky so záp. hlavou, 5x100.....
- klince krokrové 6x300.....
- stĺpové nohy s príslušenstvom.....
- základ tatranský profil -klince 3,1x80.....

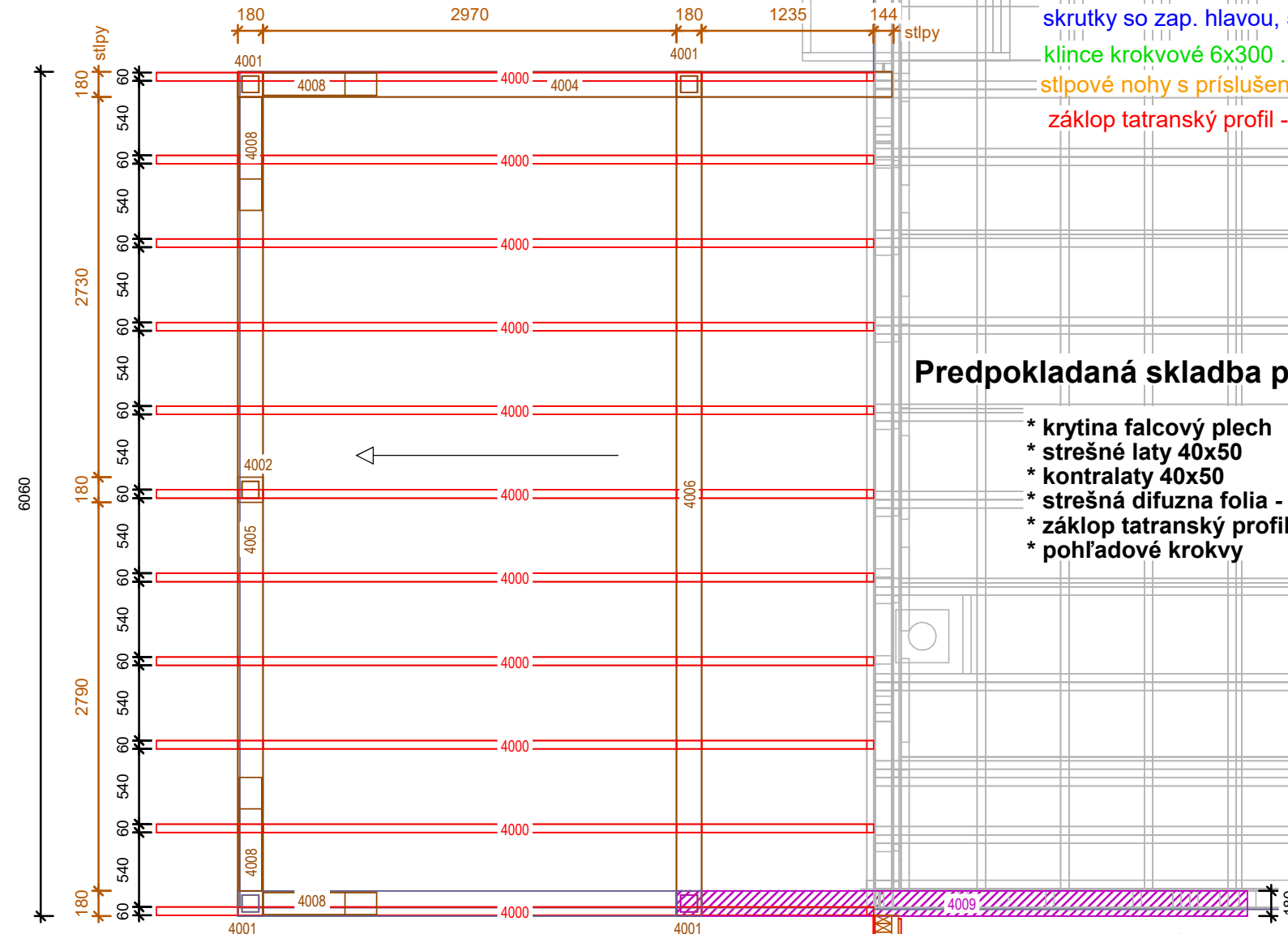
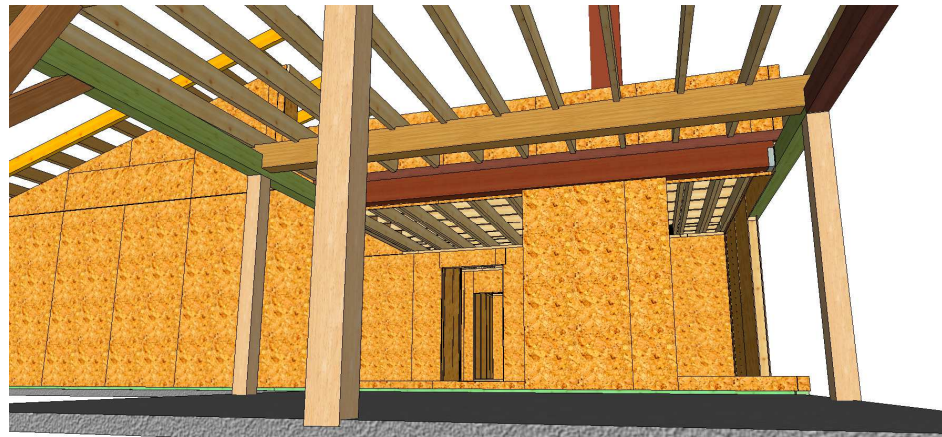

Predpokladaná skladba prístreškovej strechy

- * krytina falcový plech
- * strešné laty 40x50
- * kontralaty 40x50
- * strešná difúzna folia - poistná hydroizolácia
- * základ tatranský profil s náterom
- * pohľadové krokvy

krokvy klincovať krokrovými klincami 6x300 (pri stene skrúť so záp. hlavou)

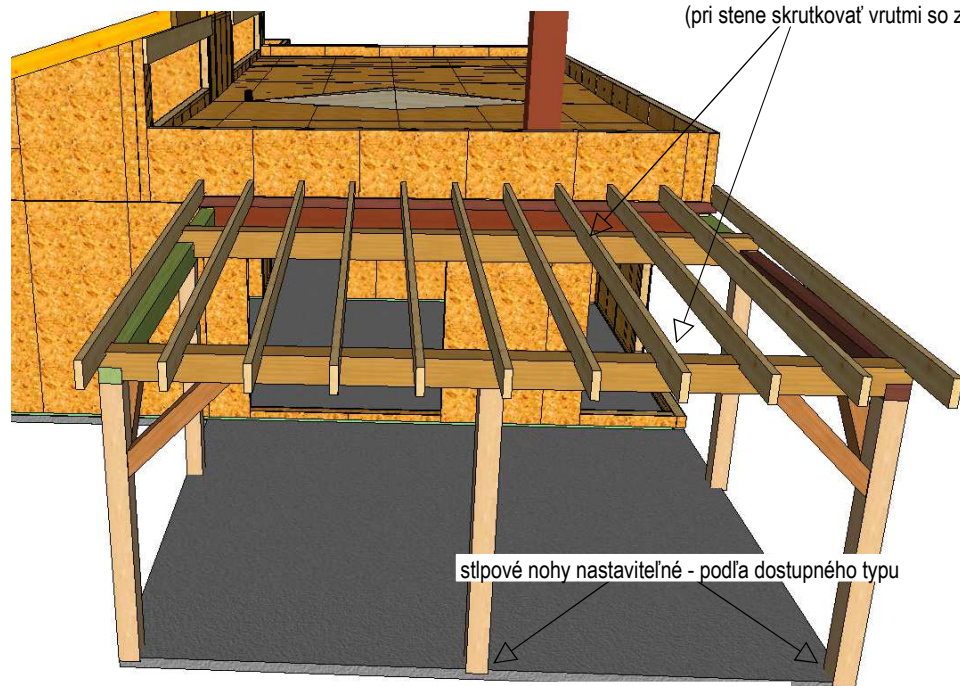

stĺpové nohy nastaviteľné - podľa dostupného typu

všetky spoje prievlakov a stĺpov zhora prekľinovať krokrovými klincami 6x260 a z boku skrúť so záp. hlavou 5x100

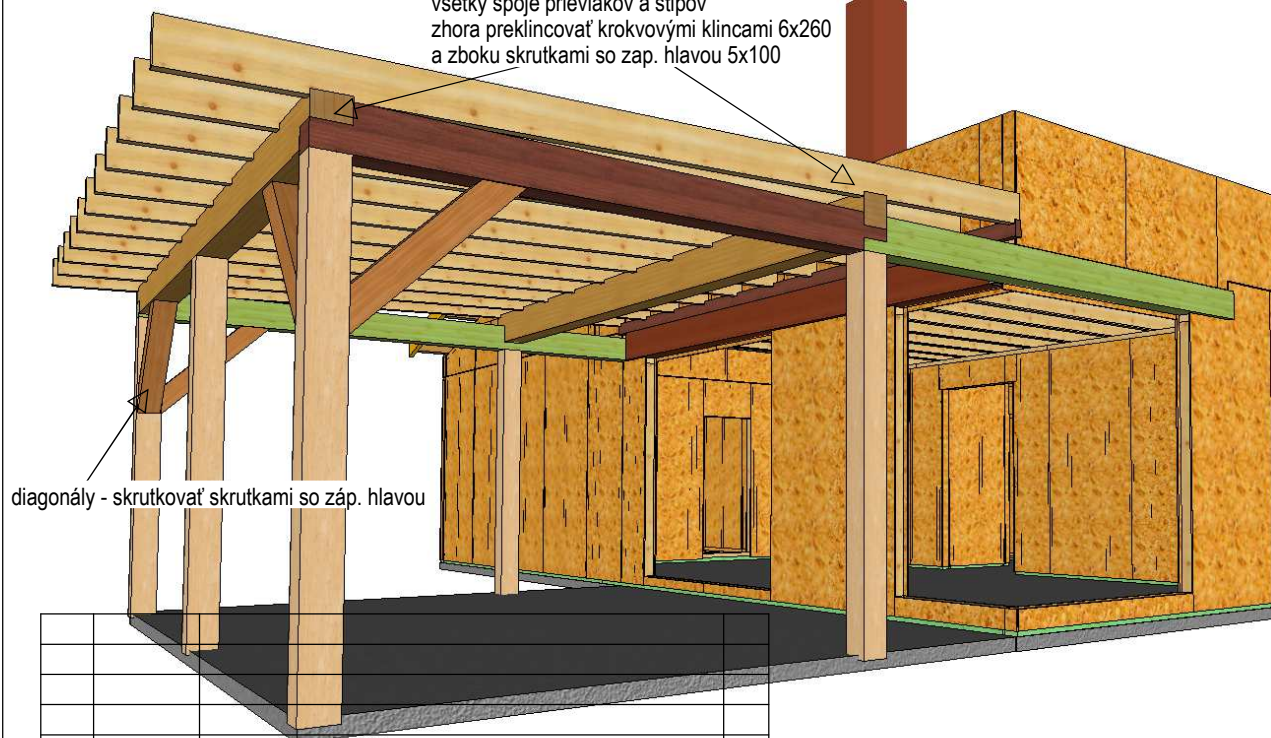

diagonály - skrúť so skrútkami so záp. hlavou

- DO PRÍBALU :**
- tatranský profil hr.15mm s náterom 35m²
 - strešná difúzna folia 38 m²
 - kontralaty a laty 40x50 180bm

- plocha prístrešku 31,20 m²
- horná strešná hrana 6,06 bm
- dolná strešná hrana - okap 6,06 bm
- bočné šikmé lemovania 2 x 5,15 bm

A	13-10-2017	CM
indice	date	modifications
		nom

Projet: RD Zábojníkovci	Carnet: 310 (placard n° 310)	Echelle: 1/10°
Maitre d'ouvrage:	Chargé d'Affaire:	N° d'affaire:
Nom du plan: montáž prístrešku		
Dessinateur:		

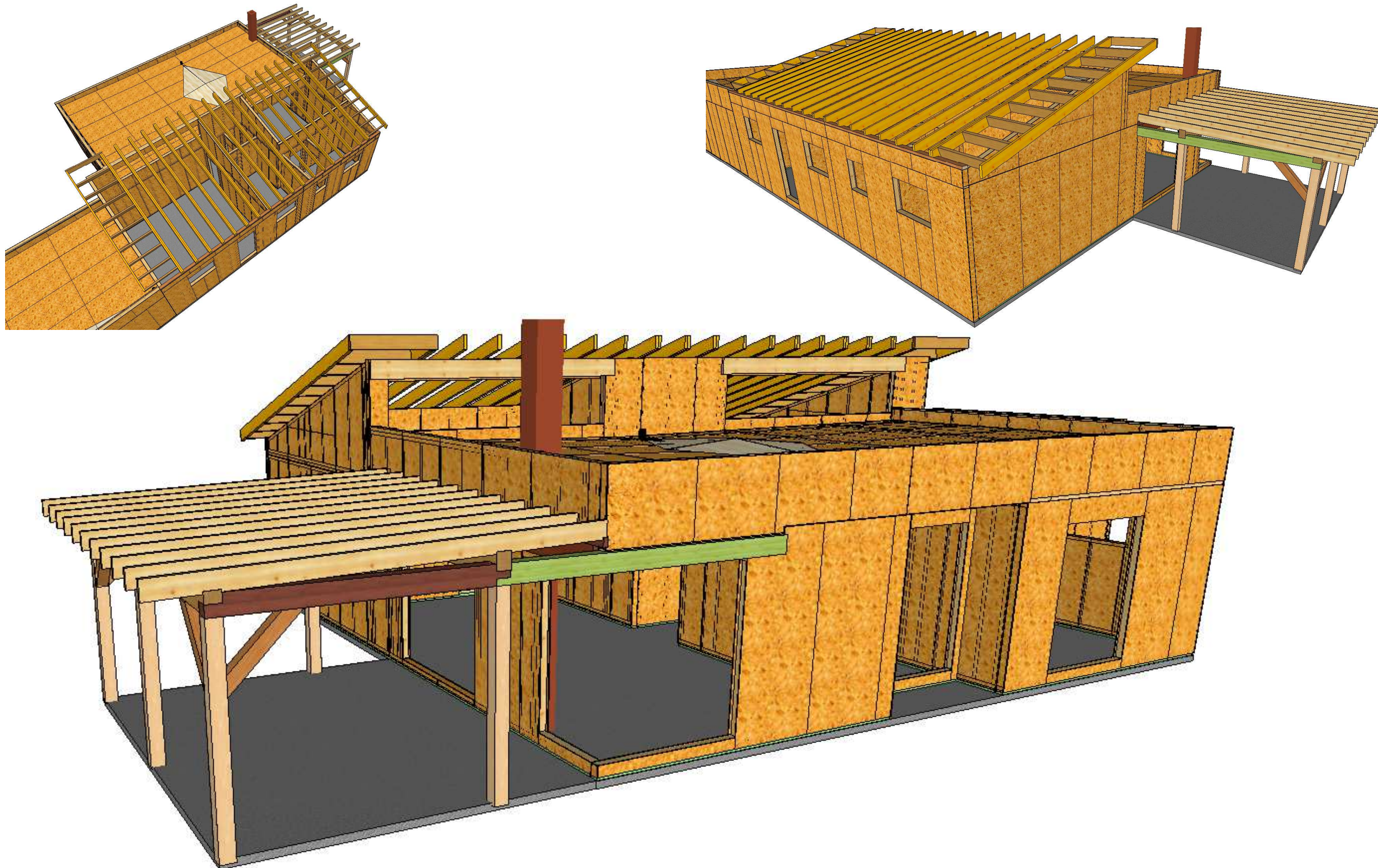

indice	date	modifications	nom
A	05-10-2017		CM

Projet: RD Zábojníkovci	Carnet: 09-x01 (placard n° x01)	Echelle: 1/10°
Maitre d'ouvrage:	Chargé d'Affaire:	N° d'affaire:
Nom du plan: vizualizacie I.		
Dessinateur:		

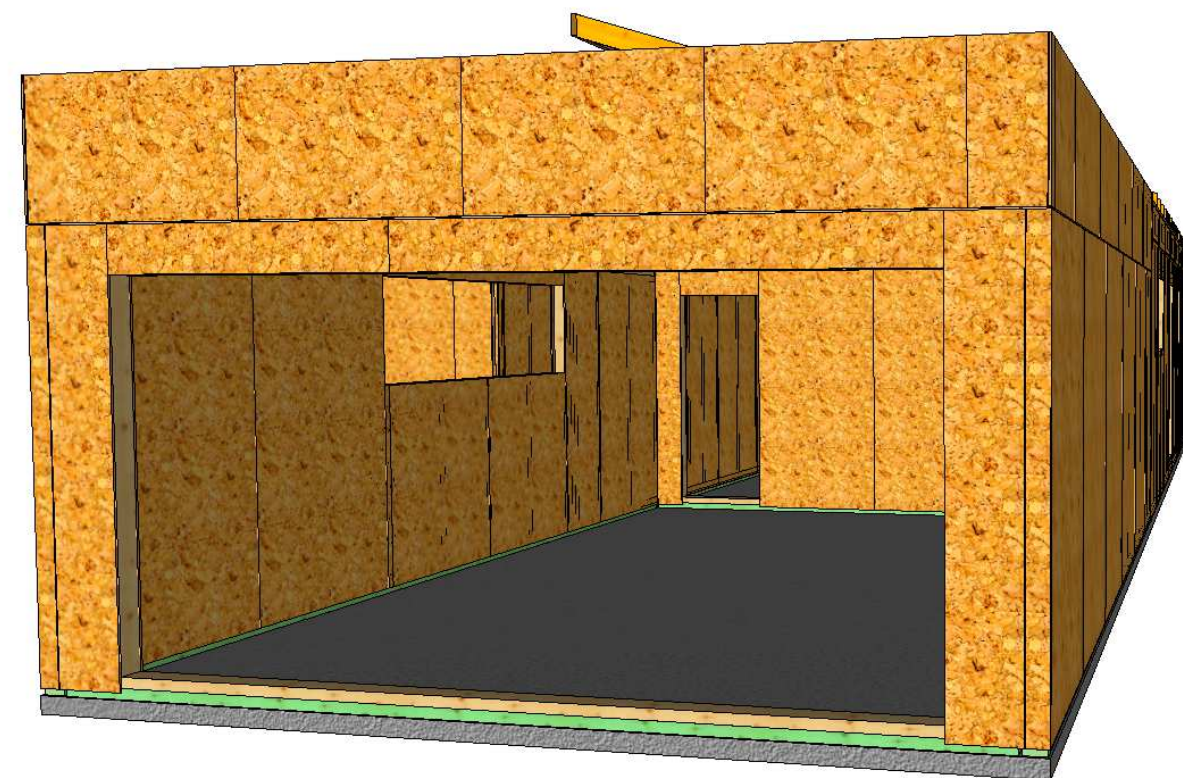
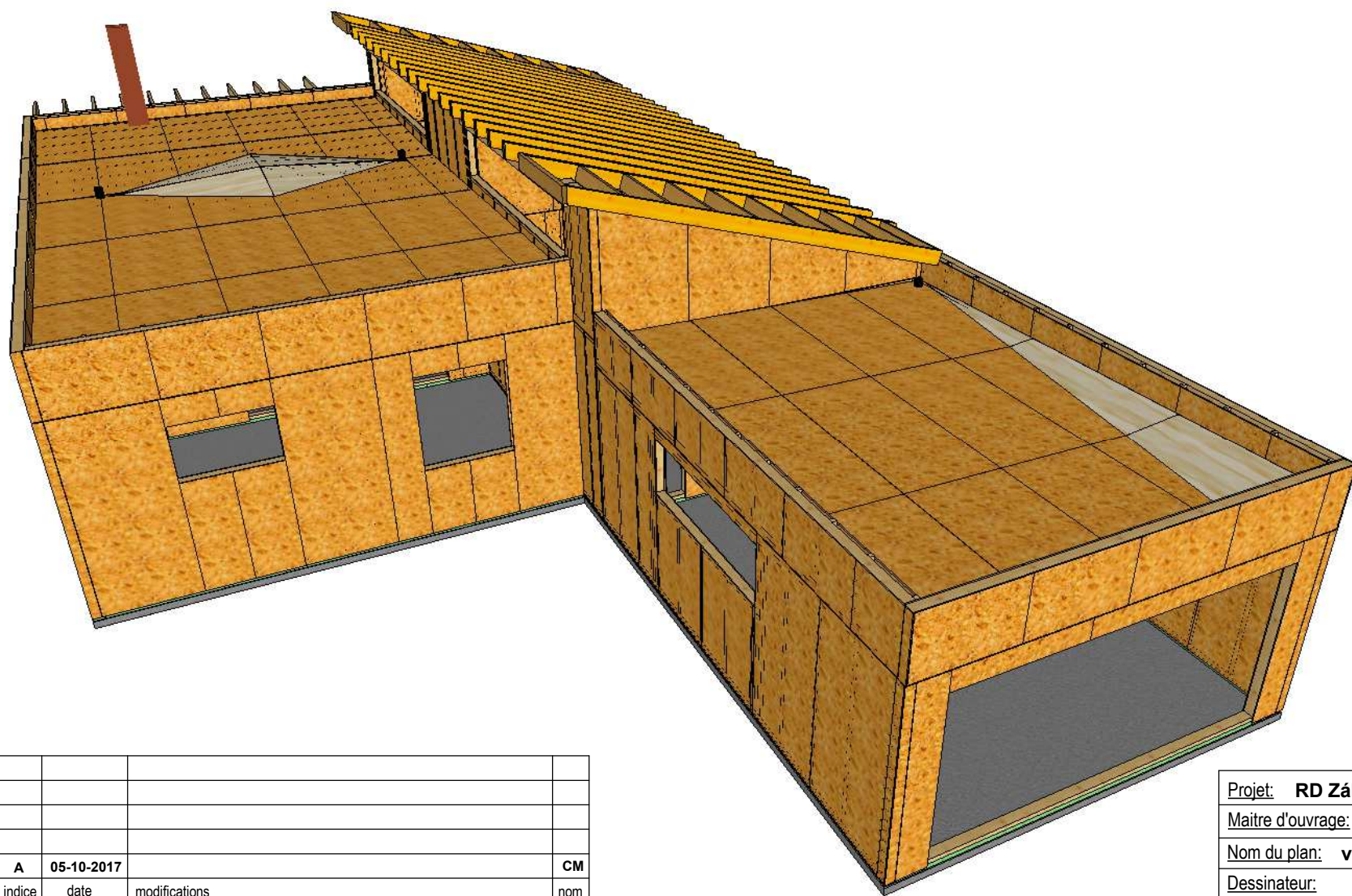
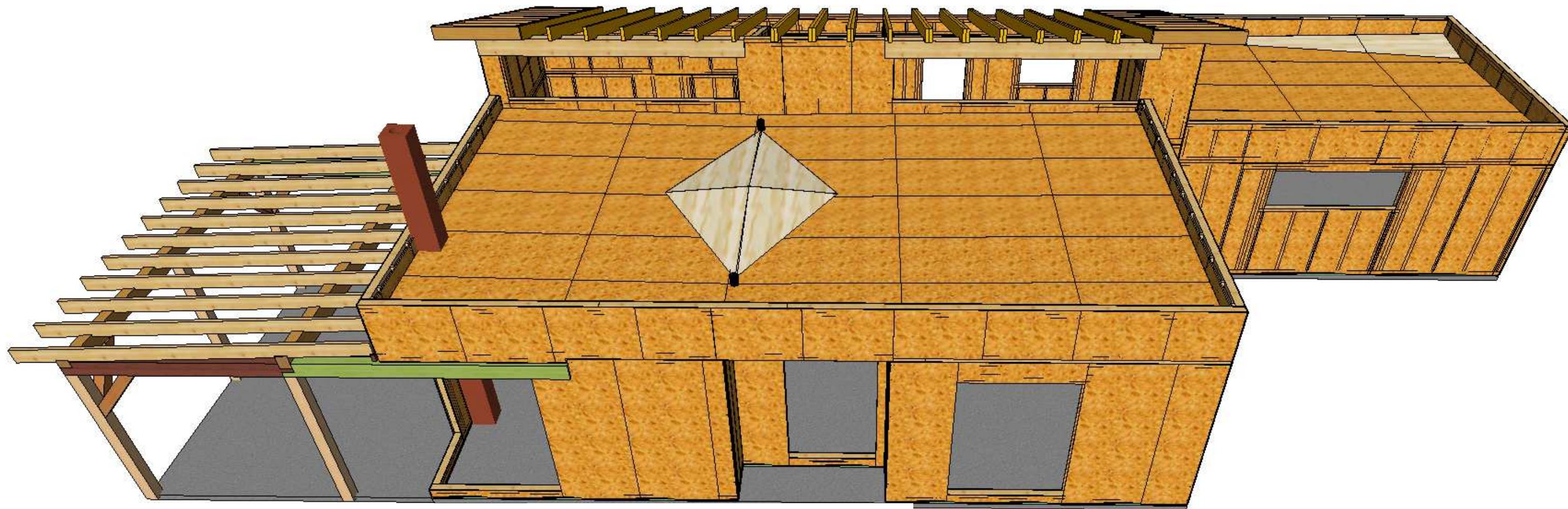

indice	date	modifications	nom
A	05-10-2017		CM

Projet: RD Zábojníkovci	Carnet: 09-x02 (placard n° x02)	Echelle: 1/10°
Maitre d'ouvrage:	Chargé d'Affaire:	N° d'affaire:
Nom du plan: vizualizacie II.		
Dessinateur:		

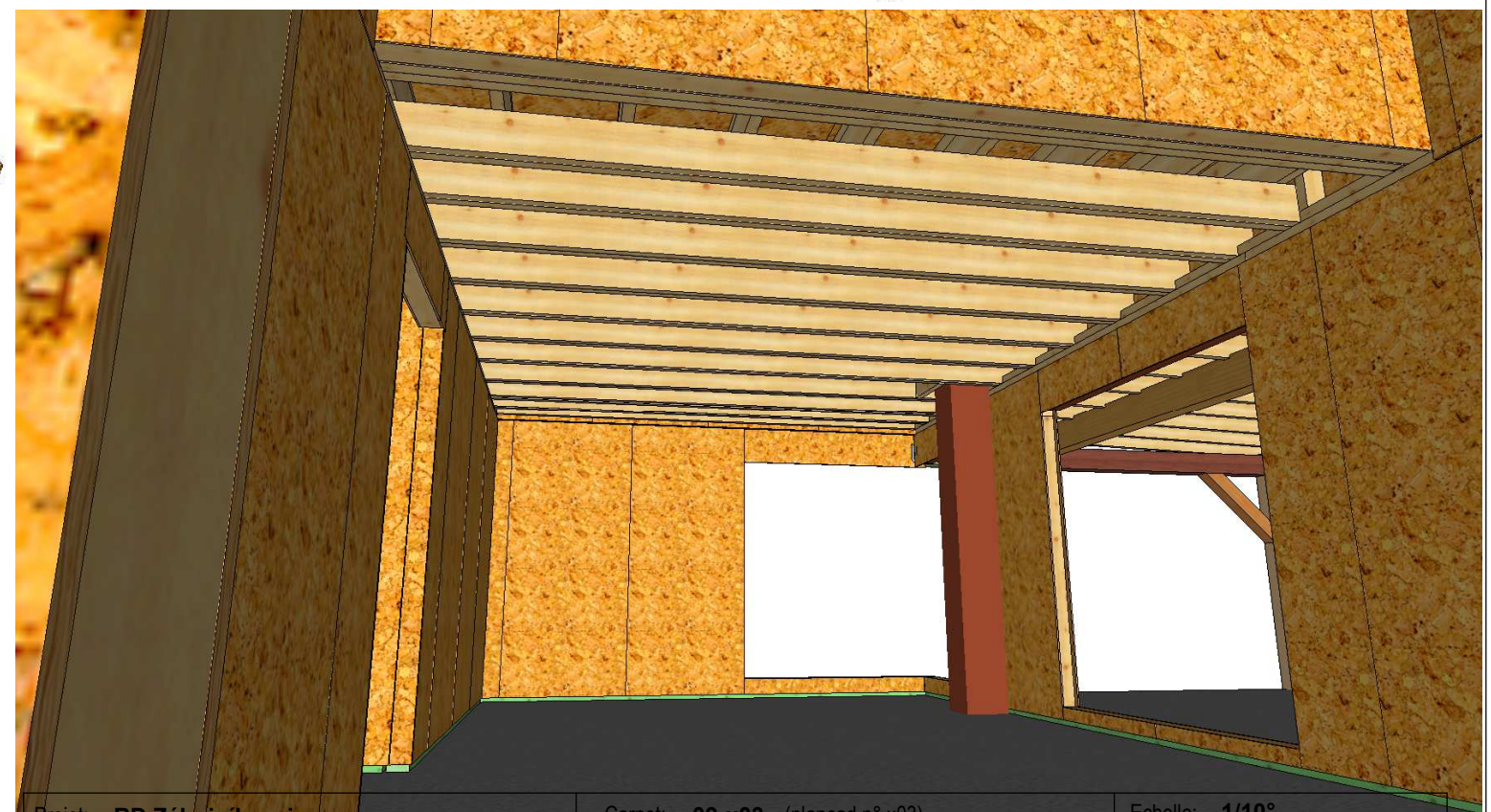
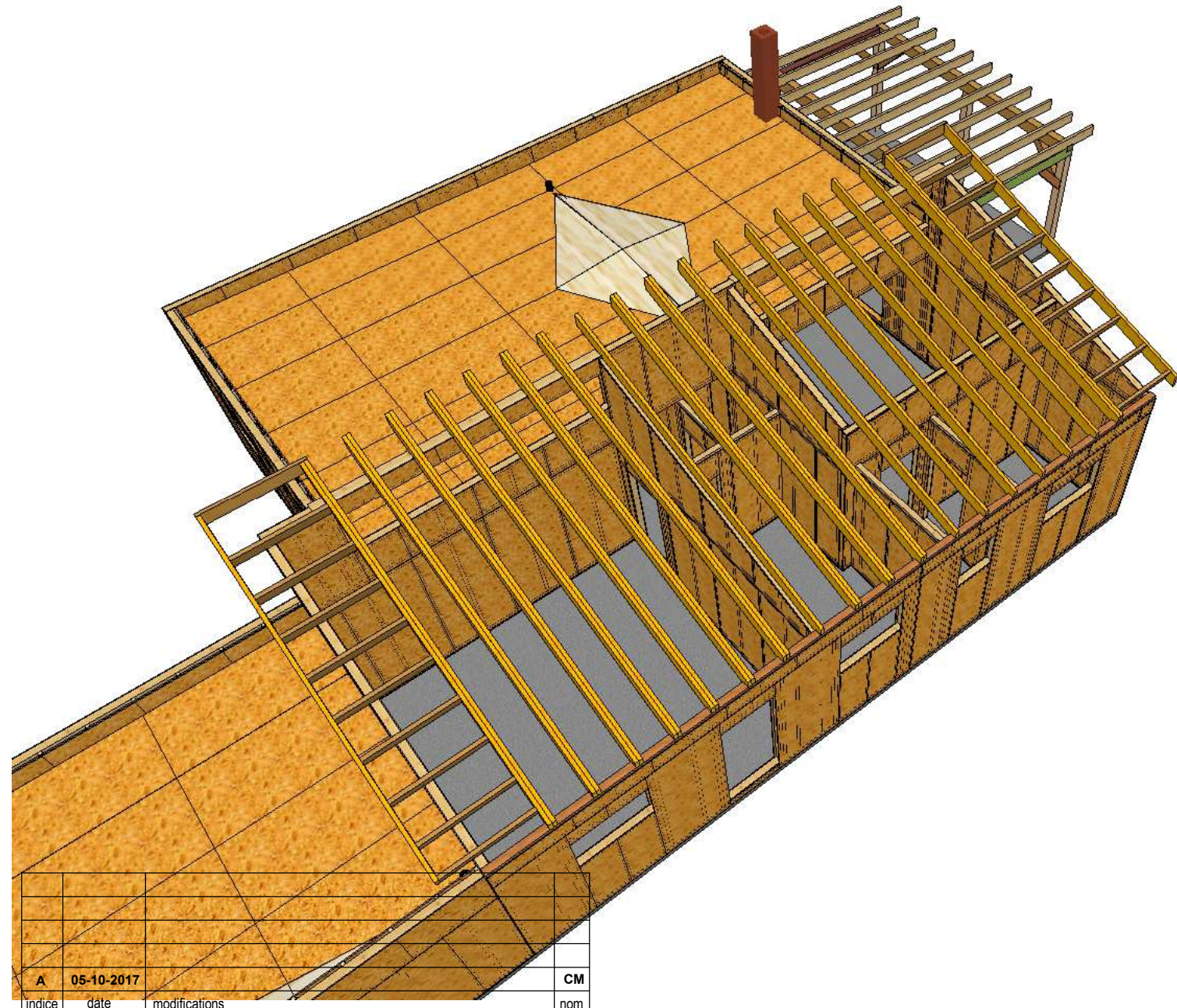
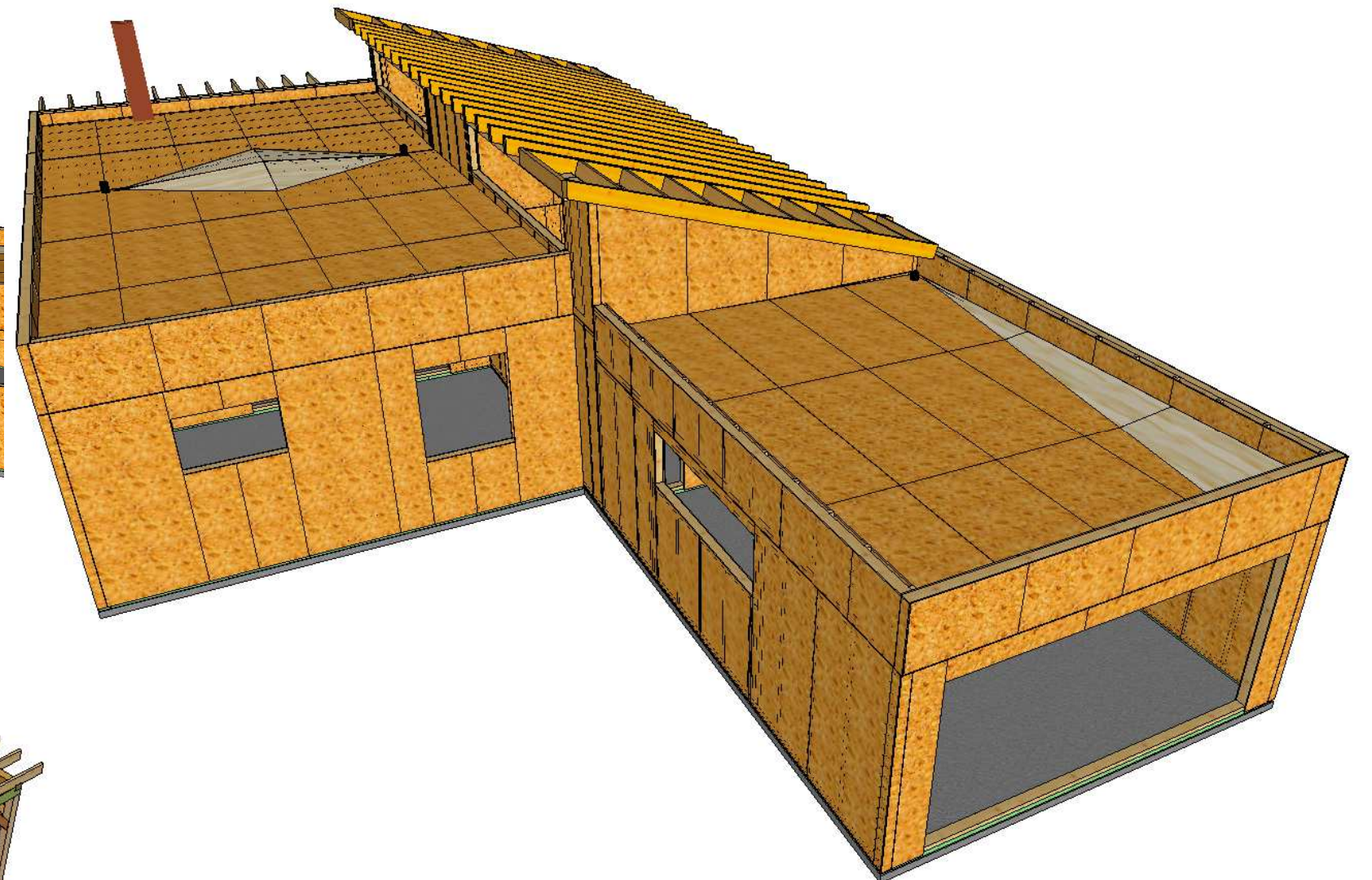
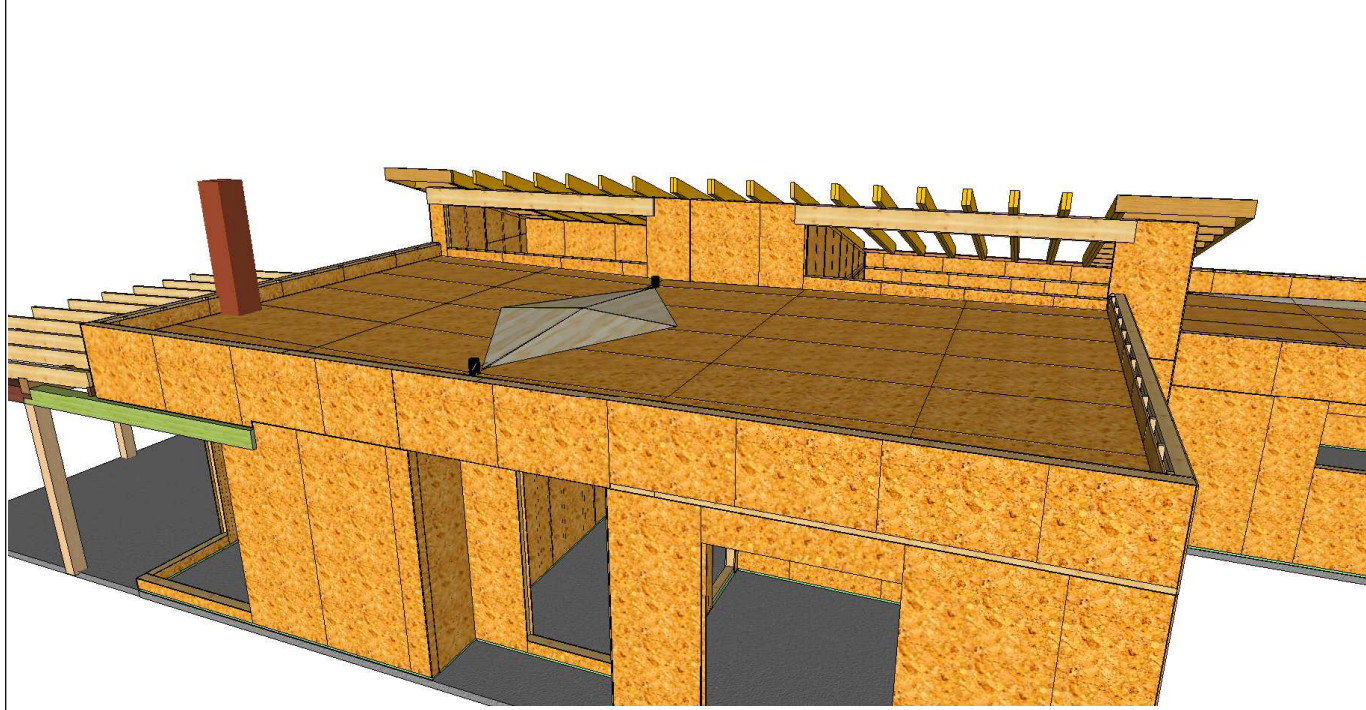

Indice	date	modifications	nom
A	05-10-2017		CM

Projet: RD Zábojníkovci	Carnet: 09-x03 (plan cad n° x03)	Echelle: 1/10°
Maitre d'ouvrage:	Chargé d'Affaire:	N° d'affaire:
Nom du plan: vizualizacie III.		
Dessinateur:		